

18^o RALLY

10 y 11 MAYO 2024

CIUTAT DE GANDIA

Trofeo Pego-Xalò



Road book

Organiza:



www.clubautomovilismogandia.com

INDICE

Generalidades	3
Solicitud reenganche al rallye	7
Mapas y ubicaciones	9
Calibrado	15
1ª Sección	19
TC1 Benicadell (A1)	27
TC2 PLANES- VALL DE GALLINERA (B1)	35
2ª Sección	43
TC3 PLANES-VALL DE GALLINERA (B2)	51
TC4 PEGO-VALL D'ALCALÀ (C1)	63
3ª Sección	73
TC5 PEGO-VALL D'ALCALÀ (C2)	79
4ª Sección	89
TC6 XALÓ TC Plus (D1)	97
TC7 XALÓ (D2)	107
TC8 VALL D'EBO (E1)	119
OK & SOS	127

CRITERIO DE CONFECCIÓN DEL ROAD BOOK

Este Libro de Ruta ha sido confeccionado en el mes de marzo y verificado durante el mes de abril.

Cualquier modificación será publicada mediante complemento, sin que la organización sea responsable de eventuales variaciones en la señalización.

Se ha puesto especial atención para facilitar su uso e interpretación, y prescindir de información considerada superficial a criterio del organizador.

Sólo se hacen constar los cruces necesarios, junto con otras informaciones de interés (gasolineras, hitos kilométricos de verificación de recorrido, etc.).

Agradeceremos todas las sugerencias que nos permitan mejorarlo.

PROCEDIMIENTO DE SEGURIDAD











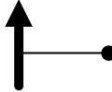

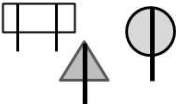
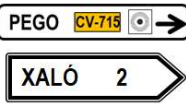

Cuando haya un cartel SOS de color rojo, es OBLIGATORIO detenerse y prestar asistencia a la tripulación que necesita ayuda.

Usted es responsable de ayudar a los accidentados y de asegurarse de que los servicios de seguridad se movilizan lo más rápido posible.

El siguiente vehículo en llegar a la escena del accidente deberá informar a Dirección de Carrera con el máximo de detalles posibles.

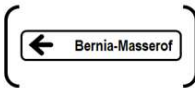
Los siguientes vehículos que lleguen a la zona del accidente deberán detenerse y dejar la carretera despejada para dejar paso a los vehículos de emergencia.

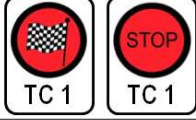
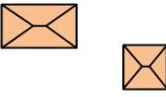
Todos los concursantes que se detengan en un tramo deberán colocar el triángulo rojo por lo menos 50 m antes del lugar incluso si el coche no está en la calzada. Todos los concursantes que se retiren del rally tienen la obligación de entregar su carnet de ruta en el punto de control más cercano lo antes posible o bien al vehículo escoba.

SIMBOLOGÍA / SYMBOL			
	Dirección a seguir Direction to follow		Medida referencia Reference measurement
	Dirección a NO Seguir (gris) Wrong direction		Siguiente viñeta en -200 m. Next bullet in -200 m.
	Hito kilométrico Milestone		Nucleo urbano, respetar velocidad Urban core, to respect speed
	Señales de tráfico Traffic signals		Señal vista trasera Sign dresses back
	Señales direccionales Directional signs		Señales NO seguir Wrong direction
	Puente paso inferior Bridge underpass		Puente paso superior Bridge top
	Difícil de ver Difficult to see		Diferentes grados de Atención Attention
	Control Horario Salida Time Control Start		Final Tramo Stop Finish S.S. Stop
	Casa o edificio House or building		Gasolinera Petrol Station

Sección	T.C. 7	C.H. 7A	KMS.	H:MM	Km/h.	Sector
1	T.C.7 (NOMBRE)	Control Horario (Nombre)	27.59	0:40	41.4	2

KMS.		DIRECCION DIRECCION	INFORMACIONES ADICIONALES ADDITIONAL INFORMATIONS	KMS. REGRESS.
TOTAL	PART.			
0.000		1	CV-749 TC 7 37.023131 -03.841047	27.585
12.400	12.400	2	CV-749 TC 7 37.053891 -03.838745	15.185
12.650	0.250	3	CV-749 TC 7 37.056615 -03.840241	14.935
12.825	0.175	4	URB. X CV-700 CV-700 L'ATZUBIA Ventas de Huelma	14.760
20.150	7.325	5	CV-700 X CV-60 CV-60 l'Olleria 150m	7.435

1	Distancia total del Sector.	2	Tiempo del sector.	3	Velocidad media del sector.
4	Fondo gris tramo cronometrado	5	Numero de vifeta	6	Distancia regresiva del tramo.
7	GPS	8	Identificación de la carretera	9	Punto de medida.
10	Punto de corte al tráfico	11	Atención (1, 2 ó 3)	12	Sin línea Próxima información a 200 mts
13	Dirección NO seguir	14	Dirección a seguir	15	Núcleo urbano
16	Situación del panel informativo	17	Cambio de carretera	18	Distancia acumulada
19	Distancia parcial entre vifetas	20	Pasar pagina rapido, próxima información en 200 m	21	Distancia regresiva del sector

XVIII Rally Ciutat de Gandia 2024								
PRIMERA SECCIÓN								
Sec.	CH	localización	Dist.TC	Dist.Enl	Dist.Tot	Tiempo Impart.	Hora 1er Coche	Prom. Km/h
1	0	Gandia - Salida parque Cerrado					7:30'	
2	1			29,690	29,690	0:40'	8:10'	44,54
	TC 1	Benicadell (A1)	10,382			0:03'	8:13'	
3	2			10,295	20,677	0:25'	8:38'	49,62
	TC 2	Planes-Vall de Gallinera (B1)	10,923			0:03'	8:41'	
	2A	Reagrup/Asistencia		19,647	30,570	0:42'	9:23'	43,67
Fin de la 1ª Sección			21,305	59,632	80,937	1:53'		
SEGUNDA SECCIÓN								
Sec.	CH	localización	Dist.TC	Dist.Enl	Dist.Tot	Tiempo Impart.	Hora 1er Coche	Prom. Km/h
		PA - A (Pego)				1:00'		
4	2B	Salida Parque de Asistencia					10:23'	
5	3			46,520	46,520	1:00'	11:23'	46,52
	TC 3	Planes-Vall de Gallinera (B2)	10,923			0:03'	11:26'	
	3A	Entrada Neut. Pego		18,977	29,900	0:42'	12:08'	42,71
		Neutralización Pego				0:30'		
6	3B	Salida Neut. Pego					12:38'	
	4			0,970	0,970	0:03'	12:41'	19,40
7	TC 4	Pego - Vall d'Alcala (C1)	15,022			0:03'	12:44'	
	4A	Reagrup/Asistencia		31,808	46,830	1:03'	13:47'	44,60
Fin de la 2ª Sección			25,945	98,275	124,220	4:24'		
TERCERA SECCIÓN								
Sec.	CH	localización	Dist.TC	Dist.Enl	Dist.Tot	Tiempo Impart.	Hora 1er Coche	Prom. Km/h
		PA - B (Pego)				1:15'		
8	4B	Salida Parque de Asistencia					15:02'	
9	5			3,870	5,970	0:15'	15:17'	23,88
	TC 5	Pego - Vall d'Alcala (C2)	15,022			0:03'	15:20'	
	5A	Reagrup/Asistencia		31,808	46,830	1:03'	16:23'	44,60
Fin de la 3ª Sección			15,022	35,678	50,700	2:36'		
CUARTA SECCIÓN								
Sec.	CH	localización	Dist.TC	Dist.Enl	Dist.Tot	Tiempo Impart.	Hora 1er Coche	Prom. Km/h
		PA - C (Pego)				0:30'		
10	5B	Salida Parque de Asistencia					16:53'	
11	6			21,970	21,970	0:30'	17:23'	43,94
	TC 6	Xaló (D1) - TC Plus	15,735			0:03'	17:26'	
	6A	Entrada Neut. Xaló (Rep. Aut.)		15,480	31,215	1:00'	18:26'	31,22
		Neutralización Xaló				0:40'		
12	6B	Salida Neut. Xaló (Rep. Aut.)					19:06'	
	7			1,360	1,360	0:15'	19:21'	5,44
13	TC 7	Xaló (D2)	15,735			0:03'	19:24'	
14	8			42,419	58,154	1:16'	20:40'	45,91
	TC 8	Vall d'Ebo (E1)	10,515			0:03'	20:43'	
	8A	Final de Rally		3,615	14,130	0:21'	21:04'	40,37
Fin de la 4ª Sección			41,985	84,844	126,829	4:41'		
Total Rallye			104,257	278,429	382,686	13:34'	27,24% velocidad	

SOLICITUD REENGANCHE AL RALLYE

En el 18 Rallye Ciutat de Gandía, el equipo formado por:

Piloto (Nombre y Apellidos)	Copiloto (Nombre y Apellidos)
-----------------------------	-------------------------------

VEHICULO Nº

SOLICITAN AL DIRECTOR DE CARRERA:

Reenganche al rallye en la sección nº _____ tras reparar avería y/o daños.

El Reenganche al rallye se llevará a cabo en los términos definidos en el Art. 26 del Reglamento Deportivo de Rallye de la Comunidad Valenciana 2.024.

En....., el de mayo de 2024.

<p>Firma:</p> <p>Nombre y apellidos persona que lo solicita</p>
--



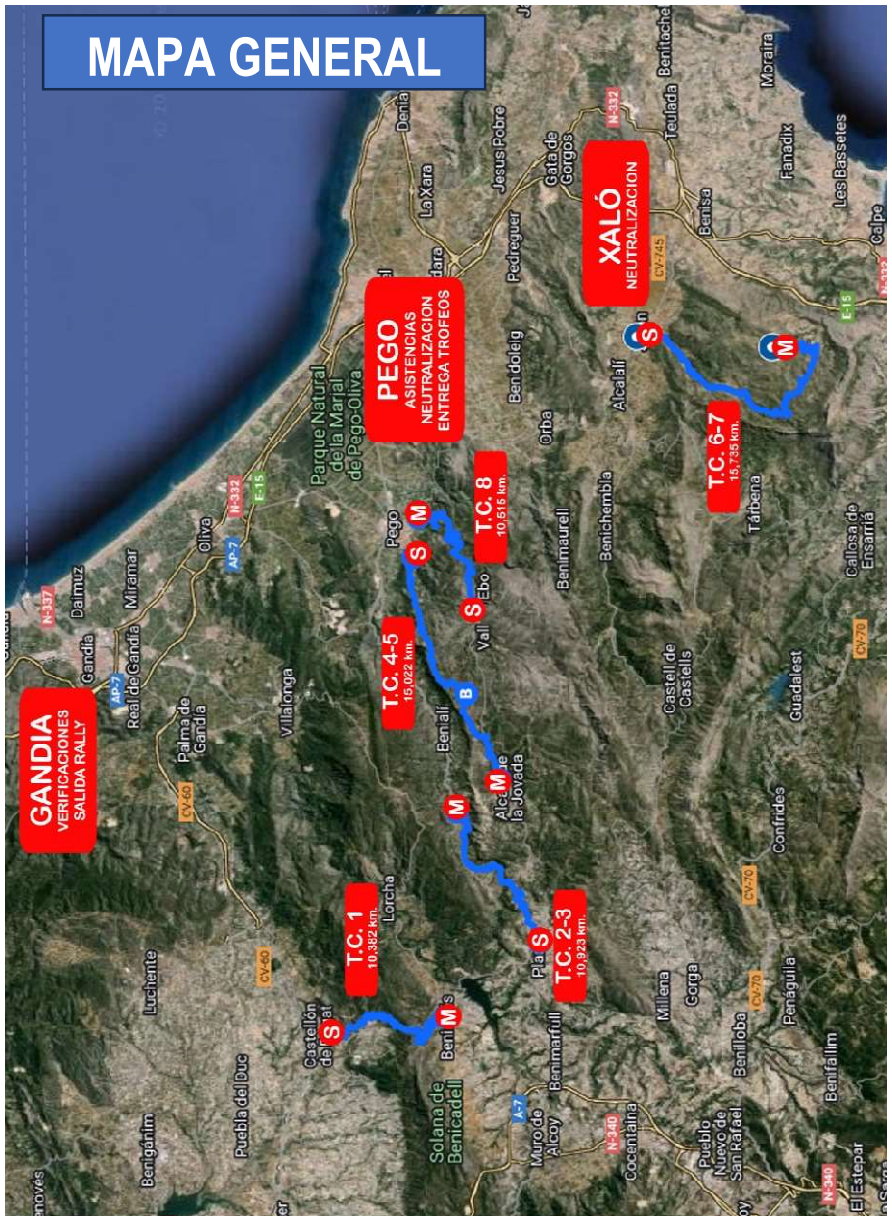

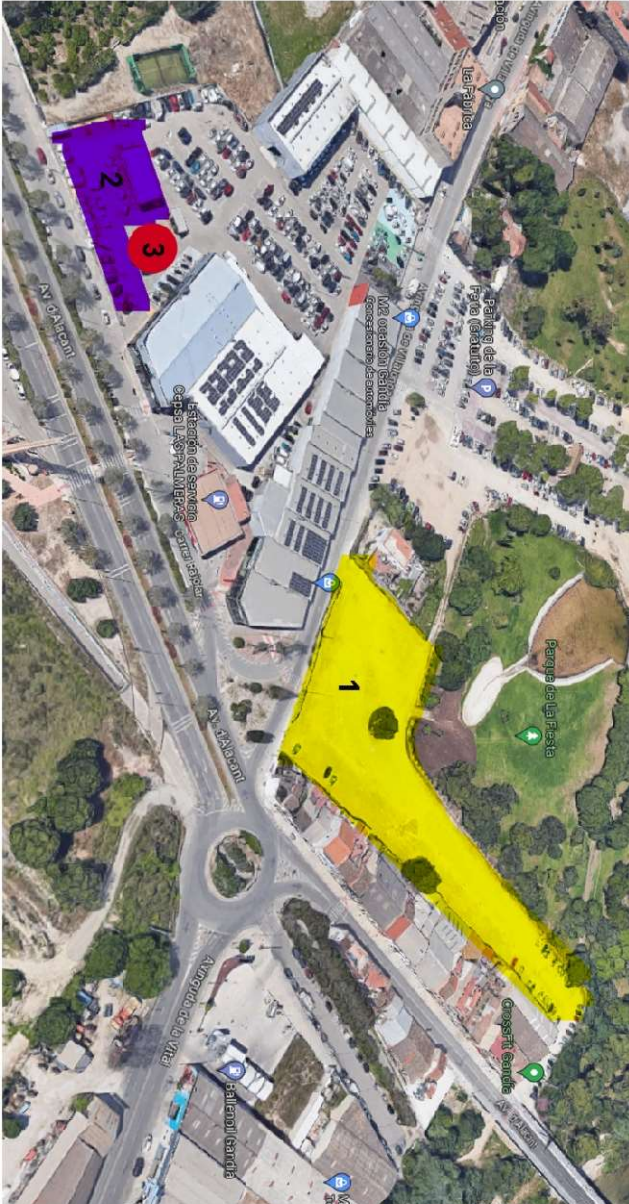

“GANDIA”

- 1 - PARKING DESCARGA Y REMOLQUES 38.96462, -0.17478, AVDA. DE VILLALONGA
- 2 - VERIFICACIONES TECNICAS 38.963526, -0.173545, AVDA. DE ALICANTE, CONCESIONARIOS MOLL MOTOR
- 3 - VER. ADMINISTRATIVAS 38.963526, -0.173545, AVDA. DE ALICANTE, CONCESIONARIOS MOLL MOTOR

“PEGO”

- 1 - OFICINA PERMANENTE 38.8445, -0.11326 C/ DUANES DE PEGO**
- 2 - PARQUE DE ASISTENCIA Y REFUELLING 38.84629, -0.11186, PASSEIG EL CLOT DE PEGO**
- 3 - FINAL RALLY- ENTREGA TROFEOS 38.846124, -0.111837**
- 4 - ZONA REMOLQUES, AVDA. JOAN CARLES I DE PEGO**

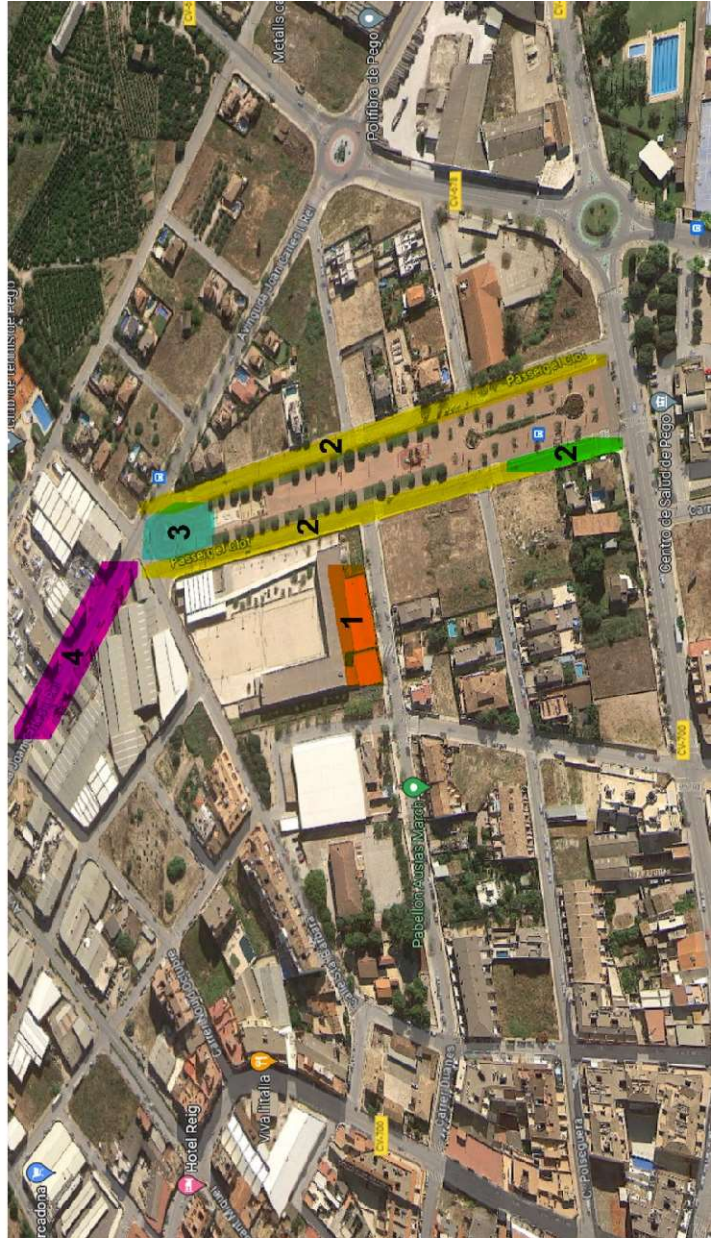



PARQUE ASISTENCIAS PEGO
PASSEIG EL CLOT
GPS: 38.843414, -0.110898

PEGO

PEGO

NEUTRALIZACIÓN PEGO
PASSEIG CERVANTES
GPS: 38.8407185, -0.1119809





NEUTRALIZACIÓN XALÓ
CAMÍ CEMENTERU.FRENTE CEIP SERRA DE BERNIA
GPS: 38.735386, -0.010003

XALÓ



CALIBRADO



TRAMO CALIBRACIÓN

Kms.

Playa de Gandía, Rotonda N-337
38.991375, -00.153059



Antes rotonda N-337 Km. 0
38.958801, -00.168343

4.119

KMS.		DIRECCIÓN DIRECTION	INFORMACIONES ADICIONALES ADDITIONAL INFORMATIONS	KMS. REGRESS.
TOTAL	PART.			
0.000		<p>Rejilla de desague</p>	<p>GPS: 38.991375, -00.153059</p>	4.119
4.119	4.119		<p>GPS: 38.958801, -00.168343</p>	0.000
4.320	0.201		<p>N-337</p> <p>Volver al inicio del tramo de calibración</p>	
<div style="border: 1px solid black; padding: 5px; margin-top: 10px;"> <p>La medición se ha realizado circulando por el centro del carril propio de la carretera, con un equipo de medición Rallymeter, con dos sondas y cuatro imanes, instalados en las ruedas traseras (no motrices).</p> </div>				<p>INICIO: en la trapa del desague, en línea verde asfalto</p> <p>FINAL: Poste señal de 60 a la derecha, en línea verde asfalto.</p>





Notas:



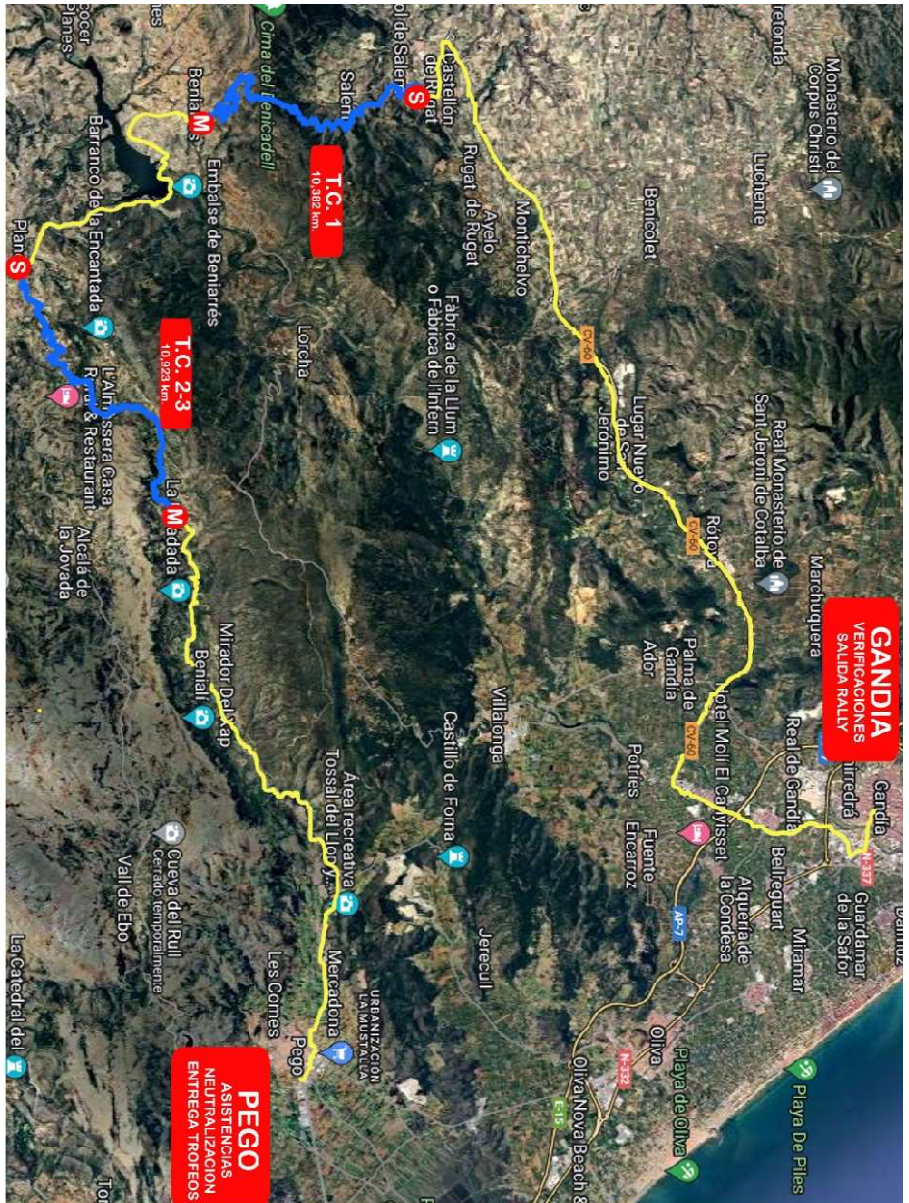

1ª SECCIÓN

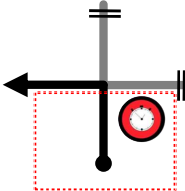

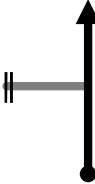
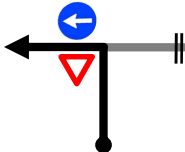
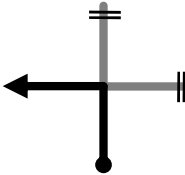
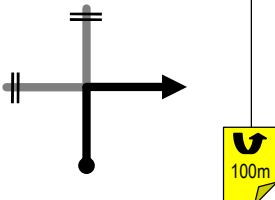



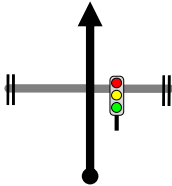
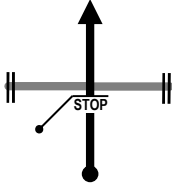
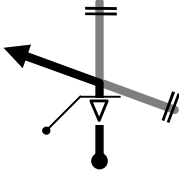

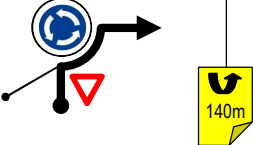

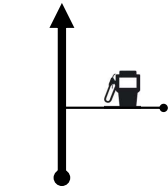

Sección	C.H. 0	C.H. 1	KMS.	H:MM	Km/h.	Sector
1	P.Cerrado Gandía	Castellón de Rugat	29.69	0:40	44.5	1

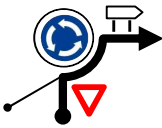
KMS.		DIRECCIÓN DIRECTION	INFORMACIONES ADICIONALES ADDITIONAL INFORMATIONS	KMS. REGRESS.
TOTAL	PART.			
0.000		1 	URB.  Plaza del Prado Gandía 38.964450 -00.182910	29.690
0.040	0.040	2 	URB. C. Ador Gandía	29.650
0.070	0.030	3 	URB. C. Morán Roda Gandía	29.620
0.240	0.170	4 	URB. C. Bailén Gandía	29.450
0.320	0.080	5 	URB. C. Legionario Bernabeu Gandía	29.370

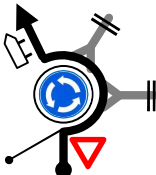

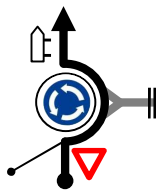

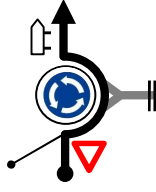
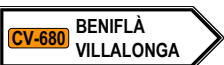

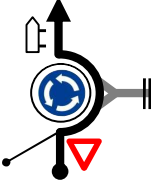

Sección	C.H. 0		C.H. 1	KMS.	H:MM	Km/h.	Sector
1	P.Cerrado Gandía		Castellón de Rugat	29.69	0:40	44.5	1

KMS.		DIRECCIÓN DIRECTION	INFORMACIONES ADICIONALES ADDITIONAL INFORMATIONS	KMS. REGRESS.
TOTAL	PART.			
0.420	0.100	6 	URB. C. Legionario Bernabeu Gandía	29.270
0.550	0.130	7 	URB. C. Legionario Bernabeu Gandía	29.140
0.640	0.090	8 	URB. C. Rafelcofer Gandía	29.050
0.820	0.180	9 	URB. Ronda l'Anella Gandía	28.870
1.280	0.460	10 	URB. C. Tetuán Gandía	28.410

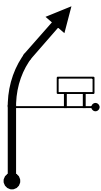

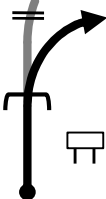

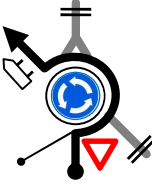

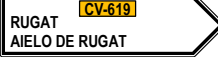

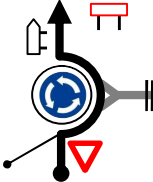

Sección	C.H. 0		C.H. 1	KMS.	H:MM	Km/h.	Sector
1	P.Cerrado Gandía		Castellón de Rugat	29.69	0:40	44.5	1

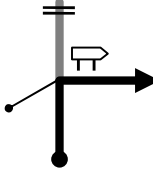
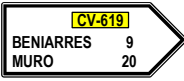
KMS.		DIRECCIÓN DIRECTION	INFORMACIONES ADICIONALES ADDITIONAL INFORMATIONS	KMS. REGRESS.
TOTAL	PART.			
1.420	0.140	11 	URB.  C. Tetuán Gandía	28.270
1.520	0.100	12 	URB. X CV-680  Avda. de Villalonga Gandía	28.170
2.800	1.280	13 	CV-680  	26.890
3.750	0.950	14 	CV-680  	25.940
5.100	1.350	15 	CV-680  	24.590

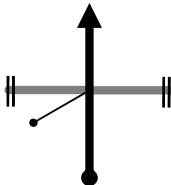
Sección	C.H. 0	C.H. 1	KMS.	H:MM	Km/h.	Sector
1	P.Cerrado Gandía	Castellón de Rugat	29.69	0:40	44.5	1

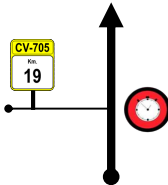
KMS.		DIRECCIÓN DIRECTION	INFORMACIONES ADICIONALES ADDITIONAL INFORMATIONS	KMS. REGRESS.
TOTAL	PART.			
5.380	0.280	16	CV-680 	24.310
6.110	0.730	17	CV-680 X CV-60 	23.580
6.310	0.200	18	CV-60   	23.380
27.120	20.810	19	CV-60 X CV-619   	2.570
27.710	0.590	20	CV-619   	1.980

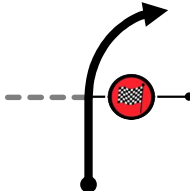
Sección	C.H. 0	C.H. 1	KMS.	H:MM	Km/h.	Sector
1	P.Cerrado Gandía	Castellón de Rugat	29.69	0:40	44.5	1

KMS.		DIRECCIÓN DIRECTION	INFORMACIONES ADICIONALES ADDITIONAL INFORMATIONS	KMS. REGRESS.
TOTAL	PART.			
28.500	0.790		CV-619 X URB.   Avda. del Camí Real Castelló de Rugat	1.190
29.090	0.590		URB.   C. Crta. De Muro Castelló de Rugat	0.600
29.390	0.300		URB. X CV-705 38.871271 -00.382016	 0.300
29.690	0.300		CV-705  38.868419 -00.382687	0.000
29.790	0.100		CV-705  38.867683 -00.381819	



Notas:



TC1

BENICADELL (A1)

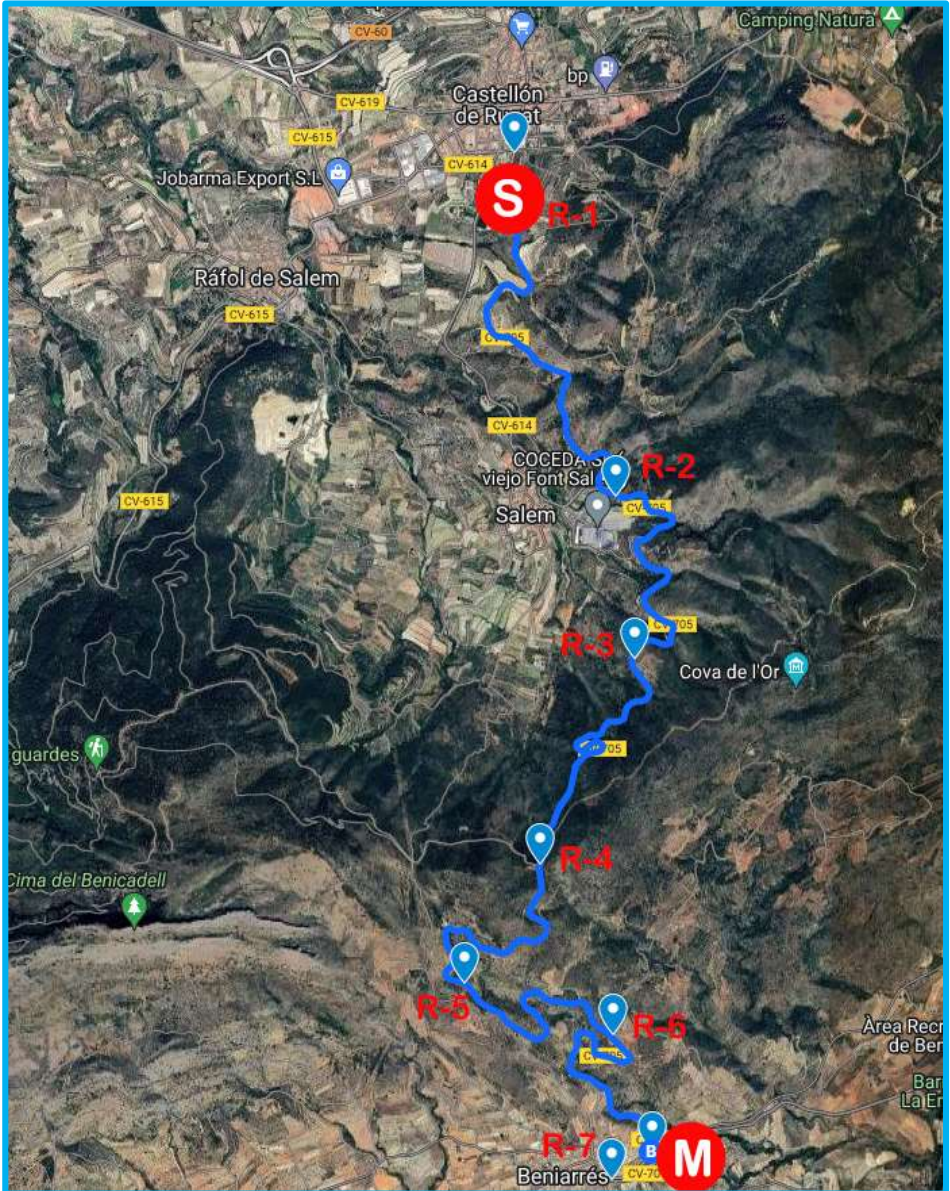

BENICADELL	T.C. A1	DISTANCIA T.C. 10,382 km.
C.H. EN HITO 19 DE LA CV-705	SALIDA T.C. EN CURVA DERECHA	

38.868419, -0.382687



38.867683, -0.381819

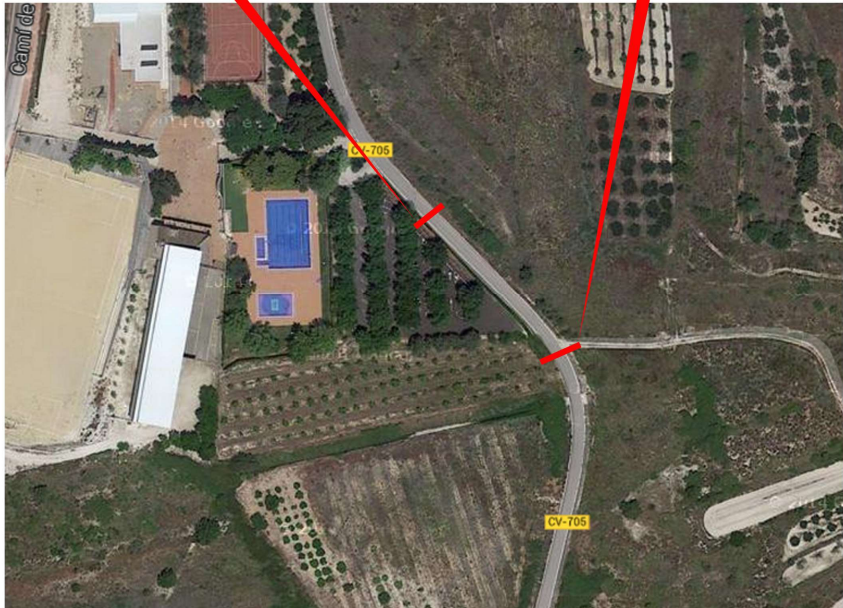

BENICADELL	T.C. A1	DISTANCIA T.C. 10,382 km.
C. STOP EN CRUCE CV-705 CON CV-701	META T.C. 1 EN CV-705 P.K. 8,720	











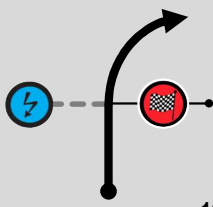

38.820454, -0.375899

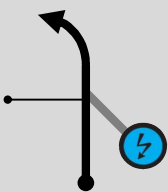

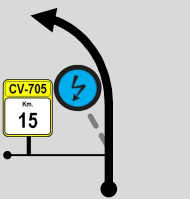

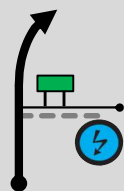

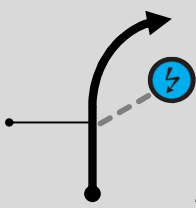



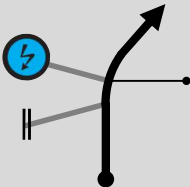

38.821770, -0.373361

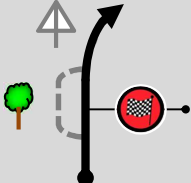

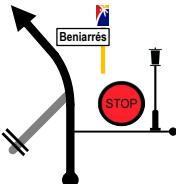



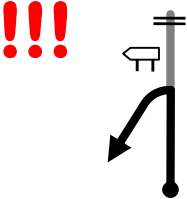

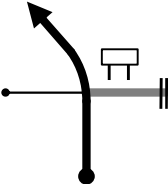
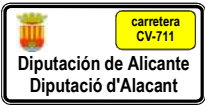
Sección	T.C. 1	C.H. 2	KMS.	H:MM	Km/h.	Sector
1	BENICADELL 	Planes	20.68	0:25	49.6	2

KMS.		DIRECCIÓN DIRECTION	INFORMACIONES ADICIONALES ADDITIONAL INFORMATIONS	KMS. REGRESS.
TOTAL	PART.			
0.000			CV-705    38.867683 -00.381819	20.680
2.300	2.300		CV-705  38.854242 -00.375724	18.380
4.040	1.740		CV-705   38.846348 -00.374484	16.640
5.860	1.820		CV-705   38.835752 -00.380482	14.820
7.360	1.500		CV-705  38.830113 -00.385359	13.320

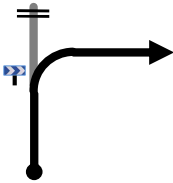
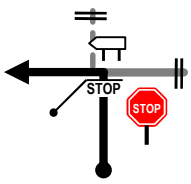
Sección	T.C. 1	C.H. 2	KMS.	H:MM	Km/h.	Sector
1	BENICADELL 	Planes	20.68	0:25	49.6	2

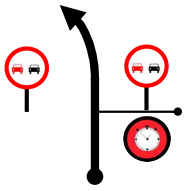
KMS.		DIRECCIÓN DIRECTION	INFORMACIONES ADICIONALES ADDITIONAL INFORMATIONS	KMS. REGRESS.
TOTAL	PART.			
8.830	1.470	6  1.552	CV-705  38.827613 -00.375891	11.850
10.382	1.552	7  0.000	CV-705  38.821770 -00.373361	10.298
10.660	0.278	8  0.000	CV-705 X URB.     38.820454 -00.375899	10.020
11.230	0.570	9  0.000	URB. X CV-711  38.820454 -00.375899	9.450
11.430	0.200	10  0.000	CV-711  38.820454 -00.375899	9.250

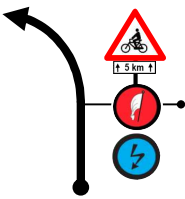
Sección	T.C. 1	C.H. 2	KMS.	H:MM	Km/h.	Sector
1	BENICADELL 	Planes	20.68	0:25	49.6	2

KMS.		DIRECCIÓN DIRECTION	INFORMACIONES ADICIONALES ADDITIONAL INFORMATIONS	KMS. REGRESS.
TOTAL	PART.			
15.270	3.840	11 	CV-711 Embalse de Beniarrés	5.410
20.590	5.320	12 	CV-711 X CV-700  38.783067 -00.335026	 0.090
20.680	0.090	13 	CV-700  38.782652 -00.334289	0.000
20.750	0.070	14 	CV-700  38.782329 -00.333106	



Notas:

TC2

PLANES-VALL DE GALLINERA (B1)

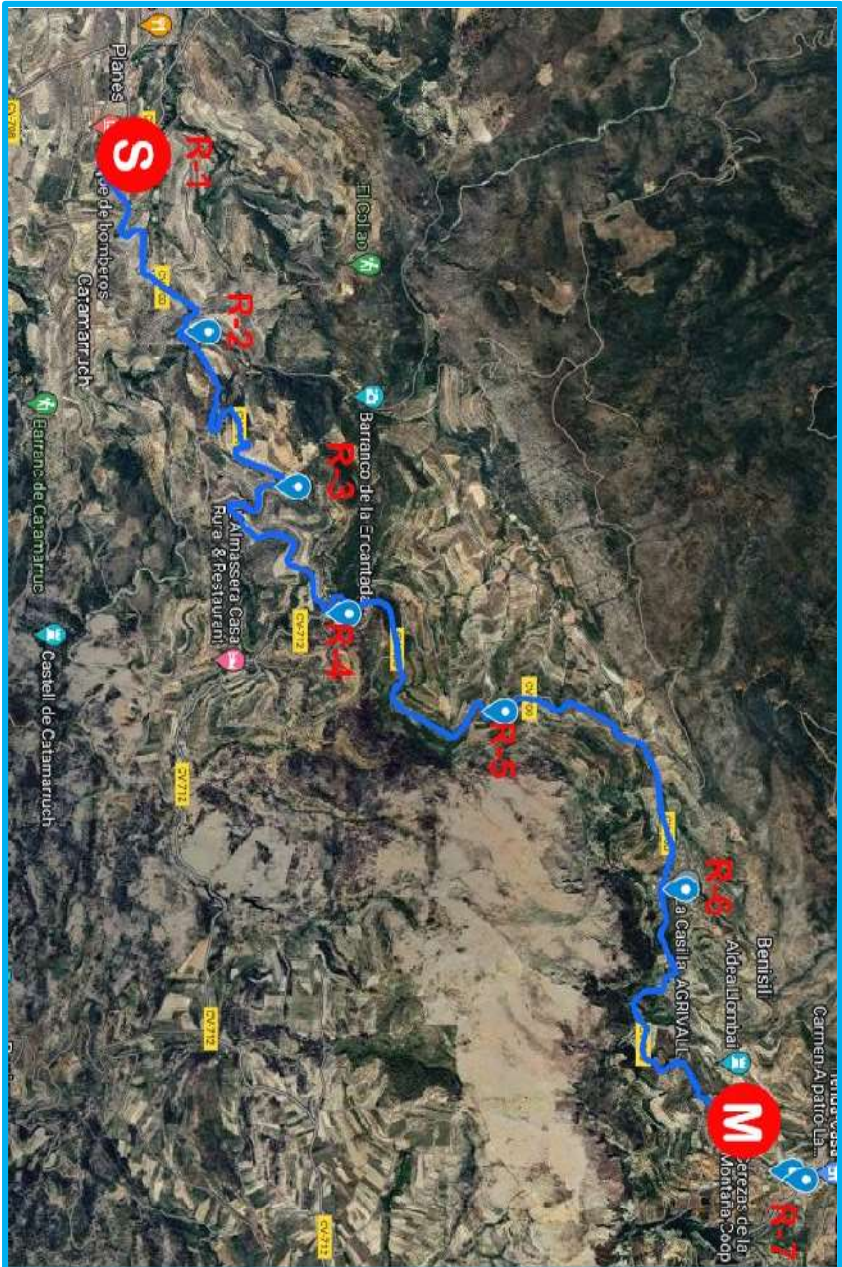

PLANES-VALL DE GALLINERA	T.C. B1-B2	DISTANCIA T.C. 10,923 km.
C.H. EN SEÑAL PROHIBIDO ADELANTAR CV-700 P.K. 27,700km	SALIDA T.C. EN SEÑAL PELIGRO BICICLETAS CV-700 P.K. 27,800	

38.782652, -0.334289

38.782329, -0.333106

PLANES- VALL DE GALLINERA	T.C. B1-B2	DISTANCIA T.C. 10,923 km.
META T.C. CV-700 P.K. 38,162	C. STOP EN SEÑAL ALPATRO	

38.816237, -0.265186













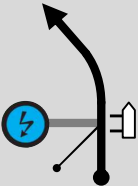

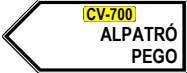
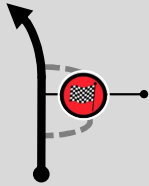
38.819280, -0.261808

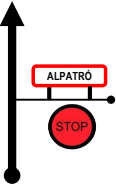

Sección	T.C. 2	C.H. 2A	KMS.	H:MM	Km/h.	Sector
1	PLANES-VALL DE GALLINERA	RGR./P.A. A Pego	30.52	0:42	43.6	3

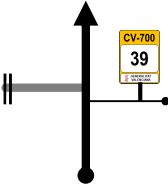
KMS.		DIRECCIÓN DIRECTION	INFORMACIONES ADICIONALES ADDITIONAL INFORMATIONS	KMS. REGRESS.
TOTAL	PART.			
0.000			CV-700 38.782329 -00.333106	30.520
1.500	1.500		CV-700 38.786621 -00.321657	29.020
3.240	1.740		CV-700 38.791690 -00.310627	27.280
4.750	1.510		CV-700 38.794517 -00.301591	25.770
6.620	1.870		CV-700 38.803156 -00.294713	23.900



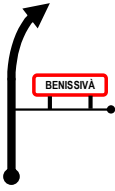
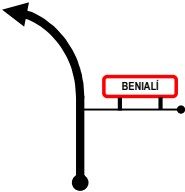
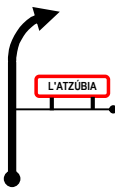
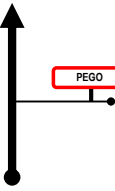
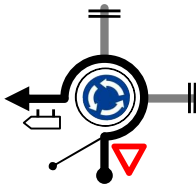

Sección	T.C. 2	C.H. 2A	KMS.	H:MM	Km/h.	Sector
1	PLANES-VALL DE GALLINERA	 RGR./P.A. A Pego	30.52	0:42	43.6	3

KMS.		DIRECCIÓN DIRECTION	INFORMACIONES ADICIONALES ADDITIONAL INFORMATIONS	KMS. REGRESS.
TOTAL	PART.			
8.760	2.140	6 	CV-700   38.813117 -00.282017	21.760
10.923	2.163	7 	CV-700  38.816237 -00.265186	19.597
11.360	0.437	8 	CV-700 X URB.    38.819280 -00.261808	19.160
11.400	0.040	9 	URB.  38.819663 -00.261450	19.120
13.860	2.460	10 	CV-700 X URB. 	16.660

Sección	T.C. 2	C.H. 2A	KMS.	H:MM	Km/h.	Sector
1	PLANES-VALL DE GALLINERA	 RGR./P.A. A Pego	30.52	0:42	43.6	3

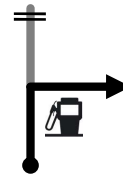
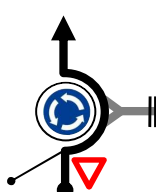
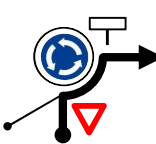
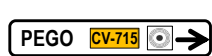
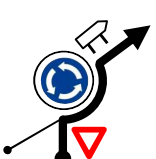
KMS.		DIRECCIÓN DIRECTION	INFORMACIONES ADICIONALES ADDITIONAL INFORMATIONS	KMS. REGRESS.
TOTAL	PART.			
16.060	2.200	11 	CV-700 X URB. BENISSIVÀ	14.460
16.840	0.780	12 	CV-700 X URB. BENIALÍ	13.680
25.790	8.950	13 	CV-700 X URB. L'ATZÚBIA	4.730
28.700	2.910	14 	CV-700 X URB. PEGO	1.820
28.910	0.210	15 	URB. CV-715 OLIVA Avda. Alcalde Fdo. Alemany PEGO	1.610

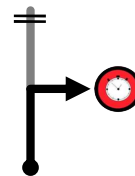
Sección	T.C. 2	C.H. 2A	KMS.	H:MM	Km/h.	Sector
1	PLANES-VALL DE GALLINERA	RGR./P.A. A Pego	30.52	0:42	43.6	3







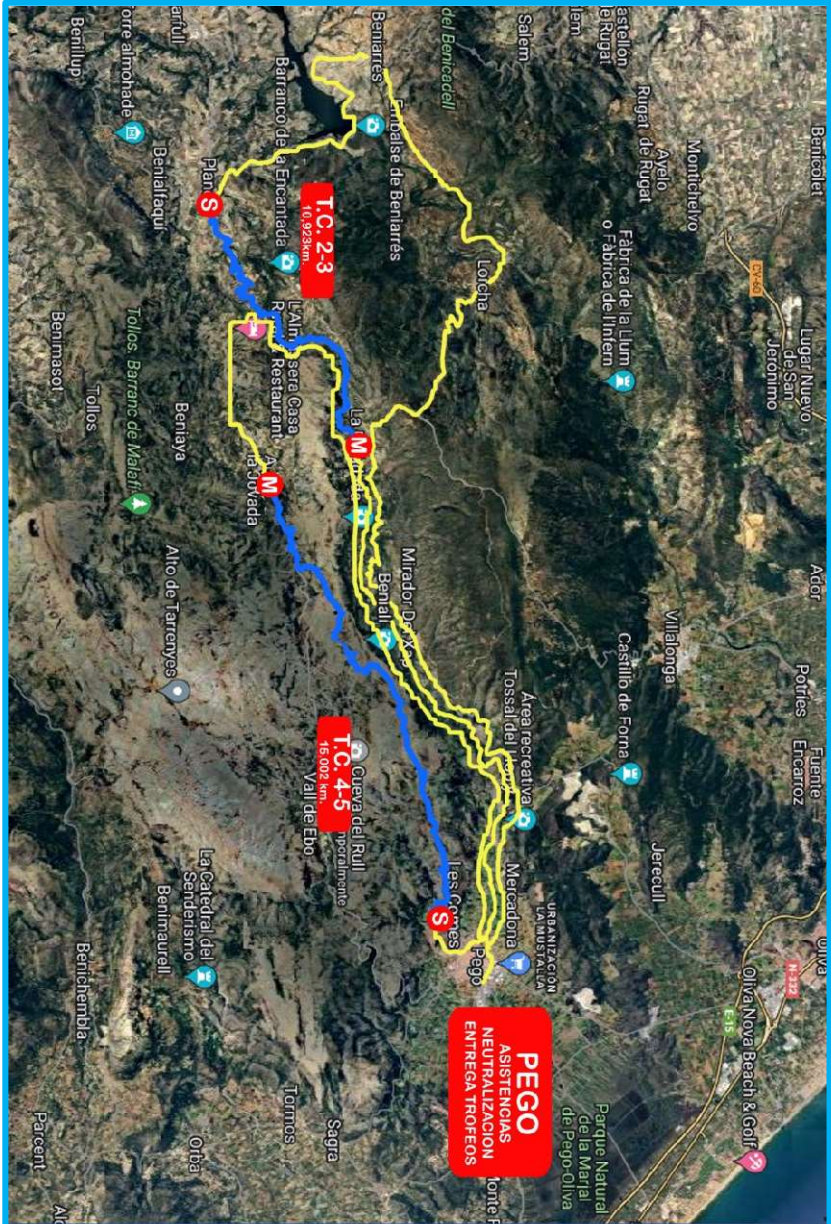

KMS.		DIRECCIÓN DIRECTION	INFORMACIONES ADICIONALES ADDITIONAL INFORMATIONS	KMS. REGRESS.
TOTAL	PART.			
29.600	0.690	!!! 	URB. Avda. Joan Carles I PEGO	0.920
29.730	0.130		URB. Avda. Joan Carles I PEGO	0.790
30.290	0.560		URB.  Avda. del Mar PEGO	0.230
30.450	0.160		URB.  C. Dénia PEGO	0.070
30.520	0.070		URB.  Parque Asistencia A IN Passeig del Clot PEGO	0.000

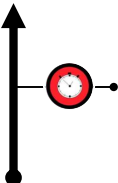

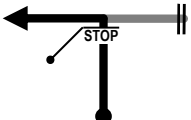
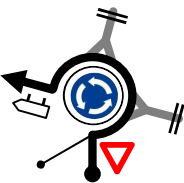

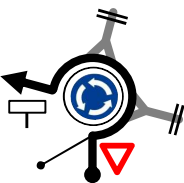



2ª SECCIÓN



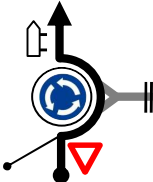
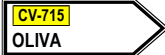



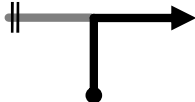
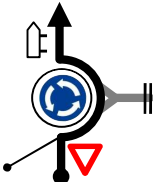



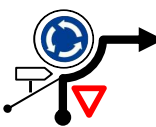

Sección	C.H. 2B	C.H. 3	KMS.	H:MM	Km/h.	Sector
2	P.Asistencia A Pego OUT 	Planes	46.52	1:00	46.5	4

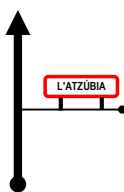
KMS.		DIRECCIÓN DIRECTION	INFORMACIONES ADICIONALES ADDITIONAL INFORMATIONS	KMS. REGRESS.
TOTAL	PART.			
0.000		1 	URB.  CH 2B Parque Asistencia A OUT Passeig del Clot PEGO	46.520
0.040	0.040	2 	URB. C. Dénia PEGO	46.480
0.140	0.100	3 	URB. (CV-678)  Avda. del Mar PEGO	46.380
0.330	0.190	4 	URB  Avda. Joan Carles I PEGO	46.190
0.910	0.580	5  	URB.  Avda. Oliva PEGO	45.610

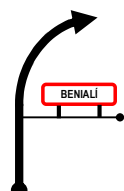

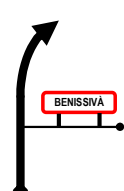

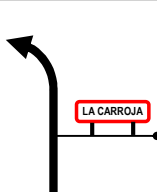
Sección	C.H. 2B	C.H. 3	KMS.	H:MM	Km/h.	Sector
2	P.Asistencia A Pego OUT	Planes	46.52	1:00	46.5	4

KMS.		DIRECCIÓN DIRECTION	INFORMACIONES ADICIONALES ADDITIONAL INFORMATIONS	KMS. REGRESS.
TOTAL	PART.			
1.010	0.100	6 	URB. 	45.510
1.090	0.080	7 	URB.  PEGO	45.430
1.180	0.090	8 	URB.  Camí de Rombí PEGO	45.340
1.280	0.100	9 	URB. C. Metge J.Pastor Alentado PEGO	45.240
1.310	0.030	10 	URB.  Avda. Alcalde F. Alemany PEGO	45.210

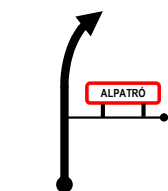

Sección	C.H. 2B	C.H. 3	KMS.	H:MM	Km/h.	Sector
2	P.Asistencia A Pego OUT	Planes	46.52	1:00	46.5	4

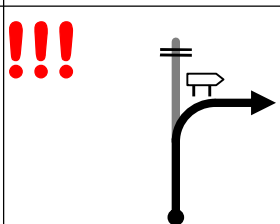
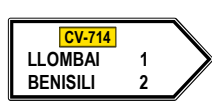
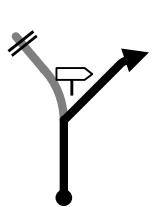
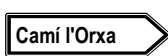
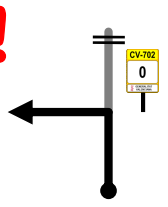
KMS.		DIRECCIÓN DIRECTION	INFORMACIONES ADICIONALES ADDITIONAL INFORMATIONS	KMS. REGRESS.
TOTAL	PART.			
2.240	0.930	11 	URB. X CV-700 	44.280
4.830	2.590	12 	CV-700 X URB. 	41.690
13.830	9.000	13 	CV-700 X URB. 	32.690
14.780	0.950	14 	CV-700 X URB. 	31.740
17.060	2.280	15 	CV-700 X URB. 	29.460

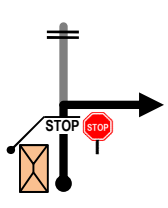



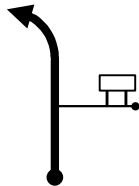
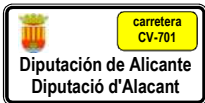
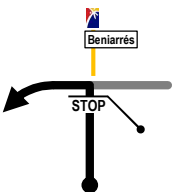
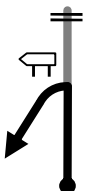

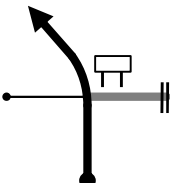
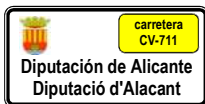
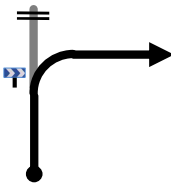
Sección	C.H. 2B	C.H. 3	KMS.	H:MM	Km/h.	Sector
2	P.Asistencia A Pego OUT	Planes	46.52	1:00	46.5	4

KMS.		DIRECCIÓN DIRECTION	INFORMACIONES ADICIONALES ADDITIONAL INFORMATIONS	KMS. REGRESS.
TOTAL	PART.			
19.400	2.340	16 	CV-700 X URB. 	27.120
19.710	0.310	17 	URB. X CV-714 	26.810
20.850	1.140	18 	CV-714 X C. l'Orxa 	25.670
22.930	2.080	19 	C. l'Orxa 	23.590
28.260	5.330	20 	C. l'Orxa X URB. L'Orxa	18.260

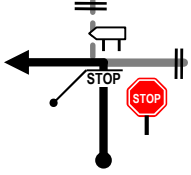
Sección	C.H. 2B	C.H. 3	KMS.	H:MM	Km/h.	Sector
2	P.Asistencia A Pego OUT	Planes	46.52	1:00	46.5	4

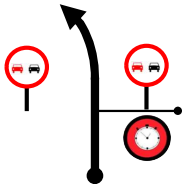
KMS.		DIRECCIÓN DIRECTION	INFORMACIONES ADICIONALES ADDITIONAL INFORMATIONS	KMS. REGRESS.
TOTAL	PART.			
29.060	0.800	21 	URB. X CV-701 	17.460
36.590	7.530	22 	CV-701 X URB. BENIARRÉS	9.930
37.160	0.570	23 	URB. X CV-711 	9.360
37.360	0.200	24 	CV-711 	9.160
41.200	3.840	25 	CV-711 Embalse de Beniarrés	5.320

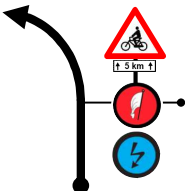
Sección	C.H. 2B	C.H. 3	KMS.	H:MM	Km/h.	Sector
2	P.Asistencia A Pego OUT 	Planes	46.52	1:00	46.5	4

KMS.		DIRECCIÓN DIRECTION	INFORMACIONES ADICIONALES ADDITIONAL INFORMATIONS	KMS. REGRESS.
TOTAL	PART.			
46.430	5.230	26 	CV-711 X CV-700  38.783067 -00.335026	 0.090
46.520	0.090	27 	CV-700  38.782652 -00.334289	0.000
46.593	0.073	28 	CV-700  38.782329 -00.333106	

TC3

PLANES-VALL DE GALLINERA (B2)

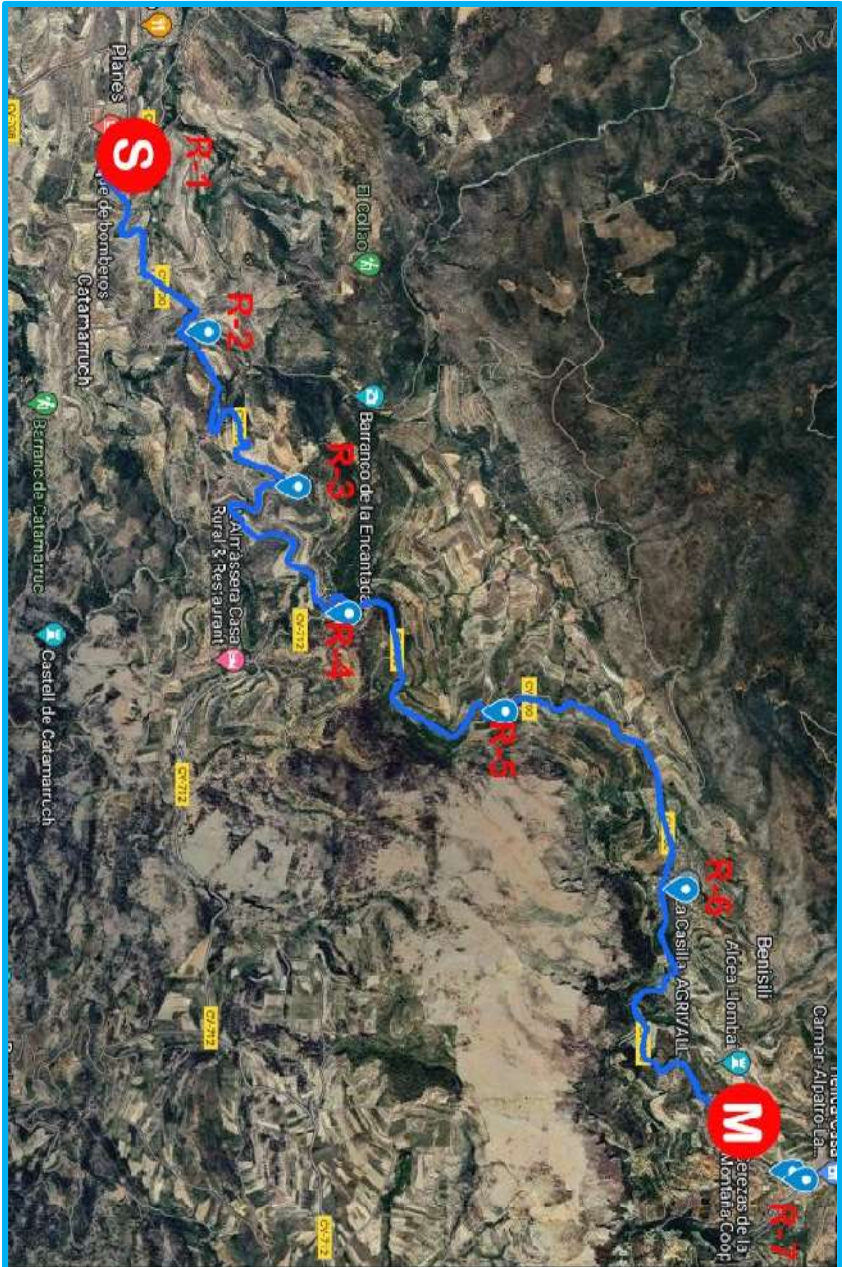

PLANES-VALL DE GALLINERA	T.C. B1-B2	DISTANCIA T.C. 10,923 km.
C.H. EN SEÑAL PROHIBIDO ADELANTAR CV-700 P.K. 27,700km	SALIDA T.C. EN SEÑAL PELIGRO BICICLETAS CV-700 P.K. 27,800	

38.782652, -0.334289



38.782329, -0.333106



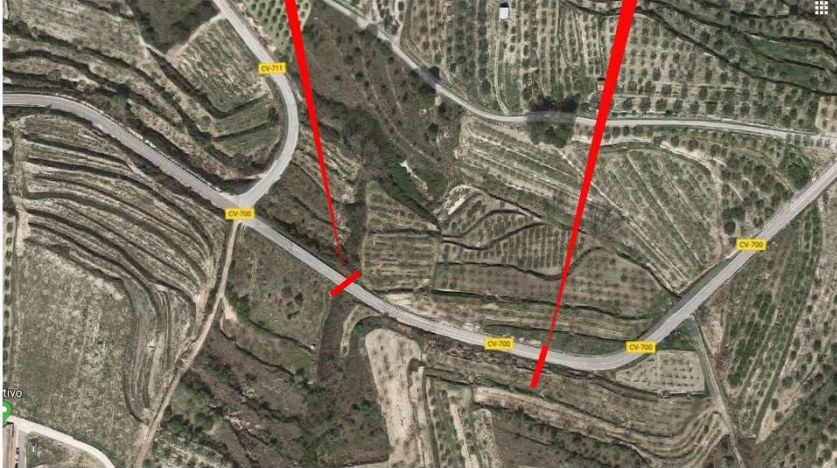

PLANES- VALL DE GALLINERA	T.C. B1-B2	DISTANCIA T.C. 10,923 km.
META T.C. CV-700 P.K. 38,162	C. STOP EN SEÑAL ALPATRO	











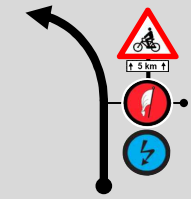

38.816237, -0.265186

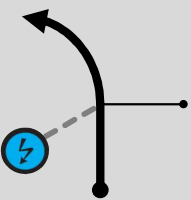

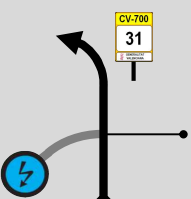

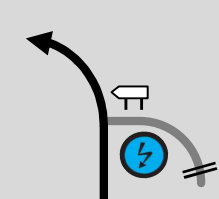

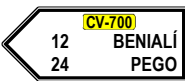
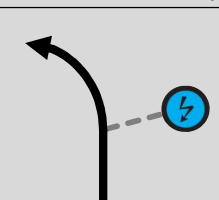





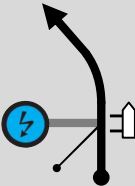

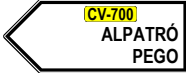
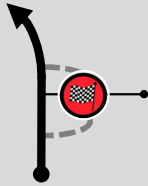
38.819280, -0.261808

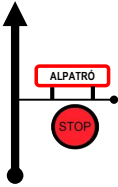

Sección	T.C. 3	C.H. 3A	KMS.	H:MM	Km/h.	Sector
2	PLANES-VALL DE GALLINERA	 Neutralización Pego IN	29.90	0:42	42.7	5

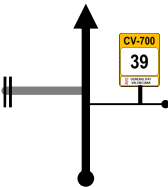
KMS.		DIRECCIÓN DIRECTION	INFORMACIONES ADICIONALES ADDITIONAL INFORMATIONS	KMS. REGRESS.
TOTAL	PART.			
0.000		1  10.923	CV-700    38.782329 -00.333106	29.900
1.500	1.500	2  9.423	CV-700  38.786621 -00.321657	28.400
3.240	1.740	3  7.683	CV-700  38.791690 -00.310627	26.660
4.750	1.510	4  6.173	CV-700   38.794517 -00.301591	25.150
6.620	1.870	5  4.303	CV-700  38.803156 -00.294713	23.280

Sección	T.C. 3	C.H. 3A	KMS.	H:MM	Km/h.	Sector
2	PLANES-VALL DE GALLINERA	 Neutralización Pego IN	29.90	0:42	42.7	5

KMS.		DIRECCIÓN DIRECTION	INFORMACIONES ADICIONALES ADDITIONAL INFORMATIONS	KMS. REGRESS.
TOTAL	PART.			
8.760	2.140	6 	CV-700   38.813117 -00.282017	21.140
10.923	2.163	7 	CV-700  38.816237 -00.265186	18.977
11.360	0.437	8 	CV-700 X URB.    38.819280 -00.261808	18.540
11.400	0.040	9 	URB.  38.819663 -00.261450	18.500
13.860	2.460	10 	CV-700 X URB. 	16.040

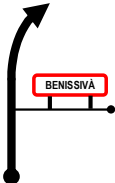
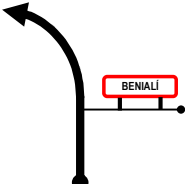
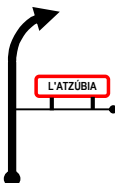
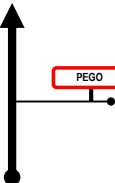
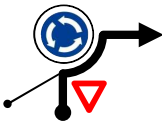

Sección	T.C. 3	C.H. 3A	KMS.	H:MM	Km/h.	Sector
2	PLANES-VALL DE GALLINERA	 Neutralización Pego IN	29.90	0:42	42.7	5

KMS.		DIRECCIÓN DIRECTION	INFORMACIONES ADICIONALES ADDITIONAL INFORMATIONS	KMS. REGRESS.
TOTAL	PART.			
16.060	2.200	11 	CV-700 X URB. BENISSIVÀ	13.840
16.840	0.780	12 	CV-700 X URB. BENIALÍ	13.060
25.790	8.950	13 	CV-700 X URB. L'ATZÚBIA	4.110
28.700	2.910	14 	CV-700 X URB. PEGO	1.200
28.910	0.210	15 	URB. Avda. Alcalde F. Alemany PEGO	0.990

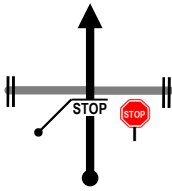
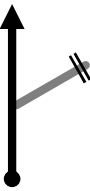
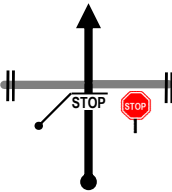
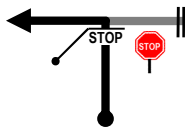
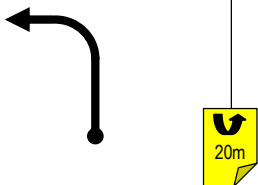
Sección	T.C. 3	C.H. 3A	KMS.	H:MM	Km/h.	Sector
2	PLANES-VALL DE GALLINERA	 Neutralización Pego IN	29.90	0:42	42.7	5

KMS.		DIRECCIÓN DIRECTION	INFORMACIONES ADICIONALES ADDITIONAL INFORMATIONS	KMS. REGRESS.
TOTAL	PART.			
29.280	0.370	16 	URB. Avda. Blasco Ibáñez PEGO	0.620
29.550	0.270	17 	URB. Avda. Blasco Ibáñez PEGO	0.350
29.620	0.070	18 	URB. Avda. Blasco Ibáñez PEGO	0.280
29.660	0.040	19 	URB. Passeig Cervantes PEGO	0.240
29.880	0.220	20 	URB. Passeig Cervantes PEGO	0.020

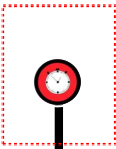



Sección	T.C. 3	C.H. 3A	KMS.	H:MM	Km/h.	Sector
2	PLANES-VALL DE GALLINERA	➔ Neutralización Pego IN	29.90	0:42	42.7	5

KMS.		DIRECCIÓN DIRECTION	INFORMACIONES ADICIONALES ADDITIONAL INFORMATIONS	KMS. REGRESS.
TOTAL	PART.			
29.900	0.020	21 	URB.  Neutralización IN Passeig Cervantes PEGO	0.000



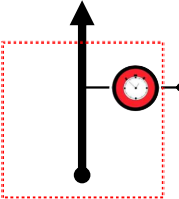

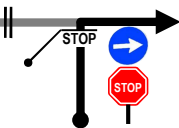
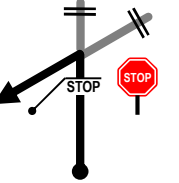
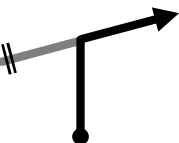
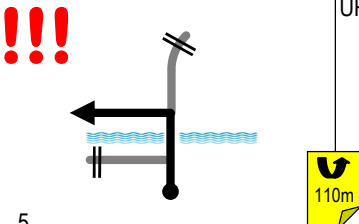

Notas:

Sección	C.H. 3B	C.H. 4	KMS.	H:MM	Km/h.	Sector
2	Neutralización Pego OUT 	Pego	0.97	0:03	19.4	6

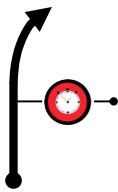
KMS.		DIRECCIÓN DIRECTION	INFORMACIONES ADICIONALES ADDITIONAL INFORMATIONS	KMS. REGRESS.
TOTAL	PART.			
0.000		1 	URB.  Neutralización OUT Paseo Cervantes PEGO	0.970
0.090	0.090	2 	URB. C. Alfonso Pellicer Mengual PEGO	0.880
0.120	0.030	3 	URB. C. Alfonso Pellicer Mengual PEGO	0.850
0.210	0.090	4 	URB. Passeig del Calvari PEGO	0.760
0.860	0.650	5 	URB. X Barranc de la Horta  38.834945 -00.127763	0.110

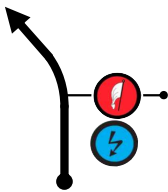
Sección	C.H. 3B	C.H. 4	KMS.	H:MM	Km/h.	Sector
2	Neutralización Pego OUT 	Pego	0.97	0:03	19.4	6

KMS.		DIRECCIÓN DIRECTION	INFORMACIONES ADICIONALES ADDITIONAL INFORMATIONS	KMS. REGRESS.
TOTAL	PART.			
0.970	0.110	6 	ND  38.834190 -00.128819	0.000
1.160	0.190	7 	ND  38.834495 -00.130123	

TC4

PEGO-VALL D'ALCALA (C1)

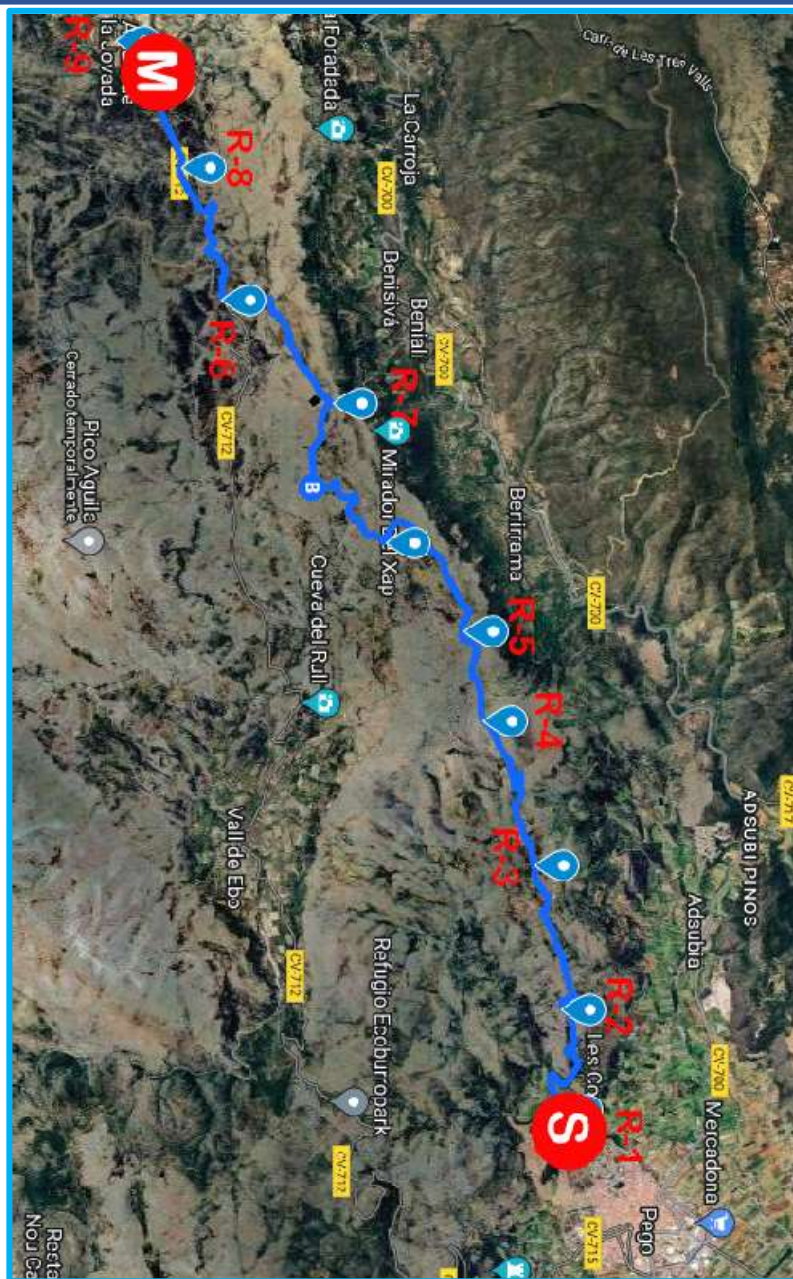

PEGO	T.C. C1-C2	DISTANCIA T.C. 15,022 km.
CAMINO S/N dirección Camp de Tir "El Miserá" Km. 0,310	CAMINO S/N dirección Camp de Tir "El Miserá" Km. 0,120	

38.834495, -0.130123



38.834190, -0.128819

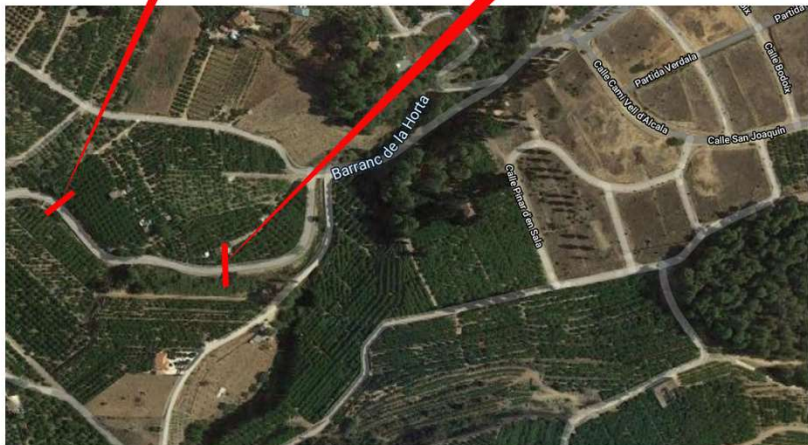



PEGO	T.C. C1-C2	DISTANCIA T.C. 15,022 km.
META TC CV-712 P.K. 5,900	CONTROL STOP CRUCE CALLES	

38.797474, -0.249576











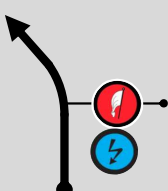

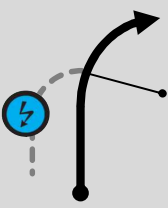

38.795997, -0.252336

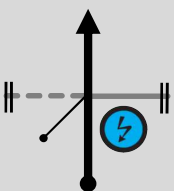

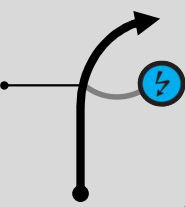

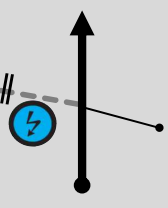





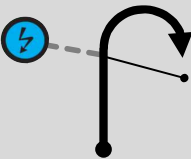

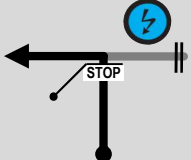

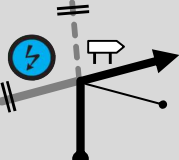

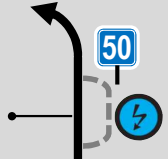

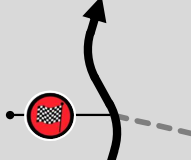



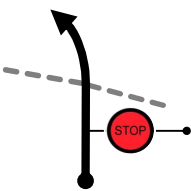

Sección	T.C. 4	C.H. 4A	KMS.	H:MM	Km/h.	Sector
2	PEGO-VALL D'ALCALÀ	 RGR./S.P. B Pego IN	46.83	1:03	44.6	7

KMS.		DIRECCIÓN DIRECTION	INFORMACIONES ADICIONALES ADDITIONAL INFORMATIONS	KMS. REGRESS.
TOTAL	PART.			
0.000		1  15.030	ND    38.834495 -00.130123	46.830
1.620	1.620	2  13.410	ND  38.835053 -00.141875	45.210
3.400	1.780	3  11.630	ND  38.832464 -00.158665	43.430
5.390	1.990	4  9.640	ND  38.827890 -00.175316	41.440
6.430	1.040	5  8.600	ND  38.825953 -00.185905	40.400

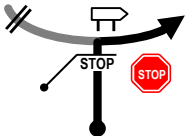
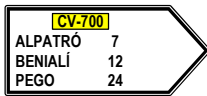
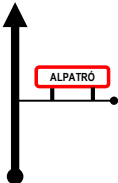
Sección	T.C. 4	C.H. 4A	KMS.	H:MM	Km/h.	Sector
2	PEGO-VALL D'ALCALÀ	 RGR./S.P. B Pego IN	46.83	1:03	44.6	7

KMS.		DIRECCIÓN DIRECTION	INFORMACIONES ADICIONALES ADDITIONAL INFORMATIONS	KMS. REGRESS.
TOTAL	PART.			
8.410	1.980	6 	ND  38.819021 -00.196297	38.420
10.420	2.010	7 	ND  38.814060 -00.212348	36.410
12.250	1.830	8 	ND X CV-712   38.804184 -00.224627	34.580
14.090	1.840	9 	CV-712  38.800376 -00.240074	32.740
15.030	0.940	10 	CV-712  38.797474 -00.249576	31.800

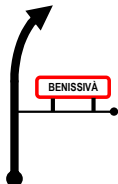



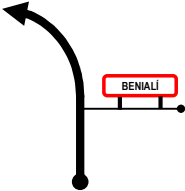
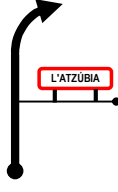
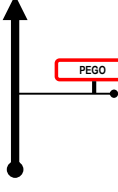
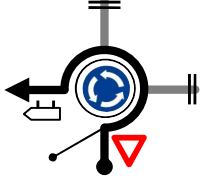
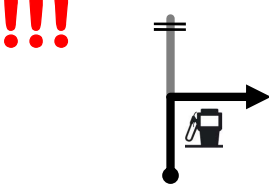

Sección	T.C. 4	C.H. 4A	KMS.	H:MM	Km/h.	Sector
2	PEGO-VALL D'ALCALÀ	 RGR./S.P. B Pego IN	46.83	1:03	44.6	7

KMS.		DIRECCIÓN DIRECTION	INFORMACIONES ADICIONALES ADDITIONAL INFORMATIONS	KMS. REGRESS.
TOTAL	PART.			
15.330	0.300	11 	CV-712    38.795997 -00.252336	31.500
21.010	5.680	12 	CV-712 X CV-700 	25.820
27.570	6.560	13 	CV-700 X URB. 	19.260
30.110	2.540	14 	CV-700 X URB. 	16.720
32.160	2.050	15 	CV-700 X URB. 	14.670

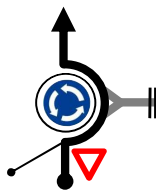
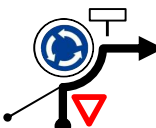
Sección	T.C. 4	C.H. 4A	KMS.	H:MM	Km/h.	Sector
2	PEGO-VALL D'ALCALÀ	 RGR./S.P. B Pego IN	46.83	1:03	44.6	7

KMS.		DIRECCIÓN DIRECTION	INFORMACIONES ADICIONALES ADDITIONAL INFORMATIONS	KMS. REGRESS.
TOTAL	PART.			
33.000	0.840		CV-700 X URB. BENIALÍ	13.830
42.030	9.030		CV-700 X URB. L'ATZÚBIA	4.800
44.900	2.870		CV-700 X URB. PEGO	1.930
45.120	0.220		URB. CV-715 OLIVA Avda. Alcalde Fdo. Alemany PEGO	1.710
45.830	0.710		URB. Avda. Joan Carles I PEGO	1.000

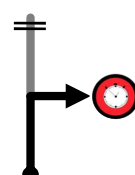
Sección	T.C. 4	C.H. 4A	KMS.	H:MM	Km/h.	Sector
2	PEGO-VALL D'ALCALÀ	 RGR./S.P. B Pego IN	46.83	1:03	44.6	7

KMS.		DIRECCIÓN DIRECTION	INFORMACIONES ADICIONALES ADDITIONAL INFORMATIONS	KMS. REGRESS.
TOTAL	PART.			
46.390	0.560	21 	URB. Avda. Joan Carles I PEGO	0.440
46.550	0.160	22 	URB.  Avda. del Mar PEGO	0.280
46.710	0.160	23 	URB.  C. Dènia PEGO	0.120
46.830	0.120	24 	URB.  Parque Asistencia B IN Passeig del Clot PEGO	0.000









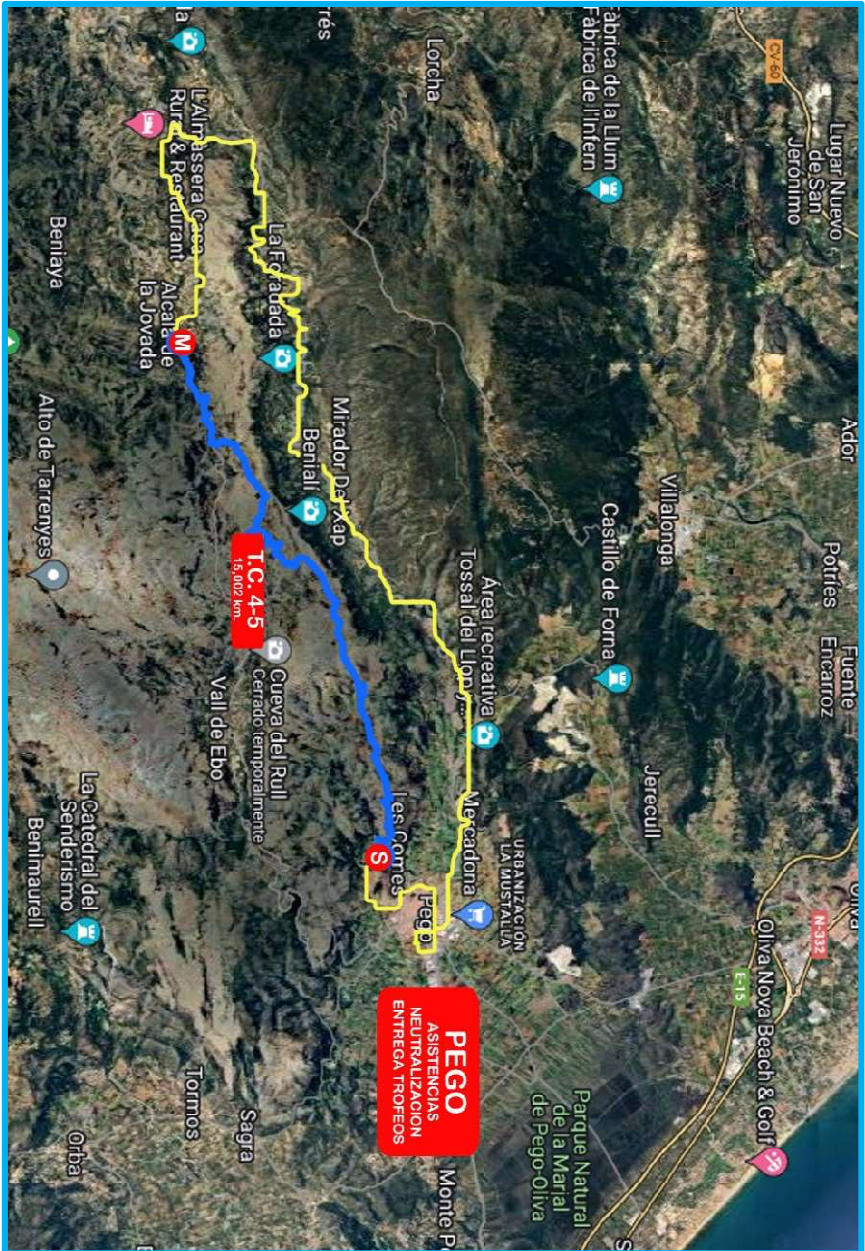

Notas:

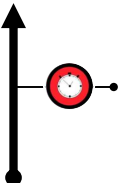

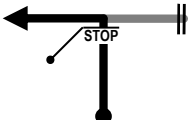
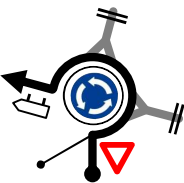

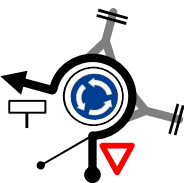

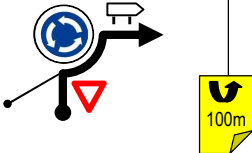

3^a SECCIÓ



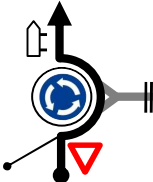
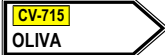

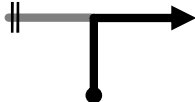
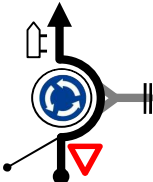

Sección	C.H. 4B	C.H. 5	KMS.	H:MM	Km/h.	Sector
3	P.Asistencia B Pego OUT 	Pego	4.38	0:15	17.5	8

KMS.		DIRECCIÓN DIRECTION	INFORMACIONES ADICIONALES ADDITIONAL INFORMATIONS	KMS. REGRESS.
TOTAL	PART.			
0.000		1 	URB.  Parque Asistencia B OUT Passeig del Clot PEGO	4.380
0.040	0.040	2 	URB. C. Dénia PEGO	4.340
0.140	0.100	3 	URB. (CV-678)  Avda. del Mar PEGO	4.240
0.330	0.190	4 	URB.  Avda. Joan Carles I PEGO	4.050
0.910	0.580	5 	URB.  Avda. Oliva PEGO	3.470



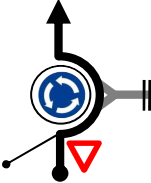
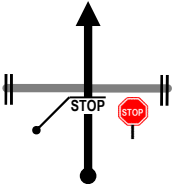
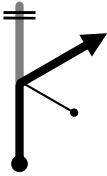
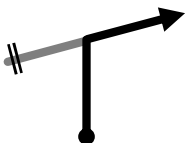
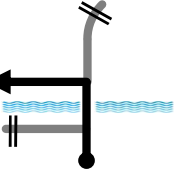

Sección	C.H. 4B	C.H. 5	KMS.	H:MM	Km/h.	Sector
3	P.Asistencia B Pego OUT	Pego	4.38	0:15	17.5	8

KMS.		DIRECCIÓN DIRECTION	INFORMACIONES ADICIONALES ADDITIONAL INFORMATIONS	KMS. REGRESS.
TOTAL	PART.			
1.010	0.100	6 	URB. 	3.370
1.090	0.080	7 	URB.  PEGO	3.290
1.180	0.090	8 	URB.  Camí de Rombí PEGO	3.200
1.280	0.100	9 	URB. C. Metge J.Pastor Alentado PEGO	3.100
1.310	0.030	10 	URB.  Avda. Alcalde F. Alemany PEGO	3.070

Sección	C.H. 4B	C.H. 5	KMS.	H:MM	Km/h.	Sector
3	P.Asistencia B Pego OUT 	Pego	4.38	0:15	17.5	8

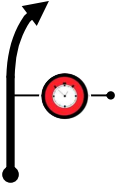
KMS.		DIRECCIÓN DIRECTION	INFORMACIONES ADICIONALES ADDITIONAL INFORMATIONS	KMS. REGRESS.
TOTAL	PART.			
2.240	0.930	11 	URB. Avda. Aquilino Barrachina PEGO	2.140
2.630	0.390	12 	URB. C. Castell de Castells/Blasco Ibañez PEGO	1.750
2.900	0.270	13 	URB. C. Alfonso Pellicer Mengual PEGO	1.480
3.620	0.720	14 	URB. Passeig del Calvari PEGO	0.760
4.270	0.650	15 	URB. X Barranc de la Horta   38.834945 -00.127763	 0.110

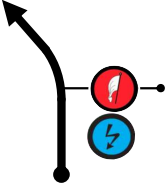
Sección	C.H. 4B	C.H. 5	KMS.	H:MM	Km/h.	Sector
3	P.Asistencia B Pego OUT	Pego	4.38	0:15	17.5	8

KMS.		DIRECCIÓN DIRECTION	INFORMACIONES ADICIONALES ADDITIONAL INFORMATIONS	KMS. REGRESS.
TOTAL	PART.			
4.380	0.110	16 	ND  38.834190 -00.128819	0.000
4.570	0.190	17 	ND  38.834495 -00.130123	



TC5

PEGO-VALL D'ALCALA (C2)

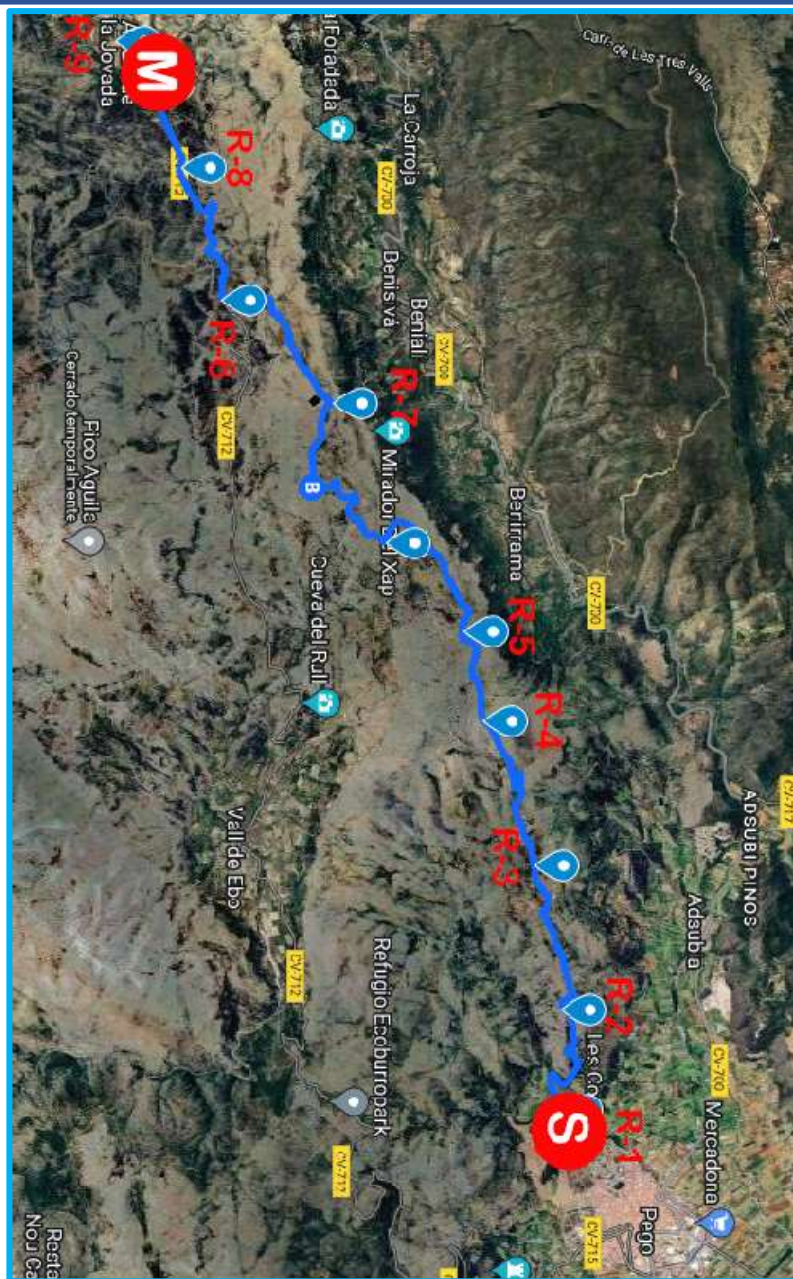

PEGO	T.C. C1-C2	DISTANCIA T.C. 15,022 km.
CAMINO S/N dirección Camp de Tir "El Miserá" Km. 0,310	CAMINO S/N dirección Camp de Tir "El Miserá" Km. 0,120	

38.834495, -0.130123



38.834190, -0.128819

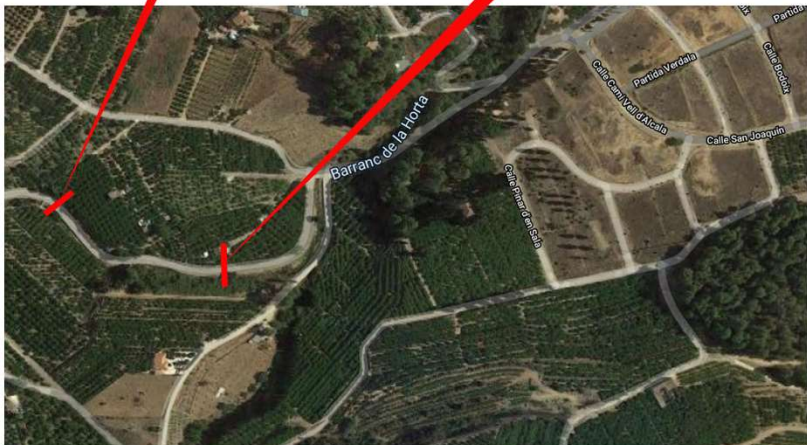



PEGO	T.C. C1-C2	DISTANCIA T.C. 15,022 km.
META TC CV-712 P.K. 5,900	CONTROL STOP CRUCE CALLES	

38.797474, -0.249576











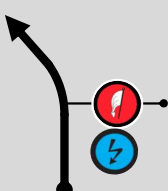

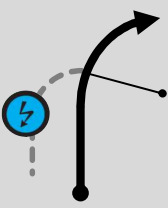

38.795997, -0.252336

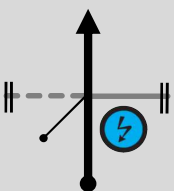

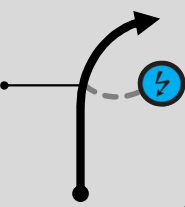

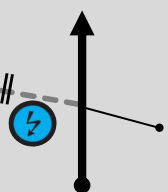





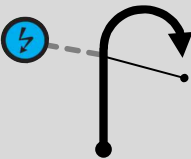

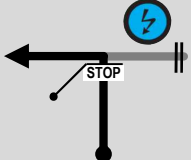

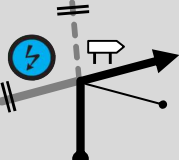

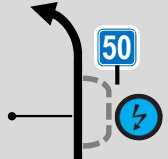

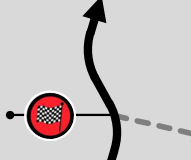

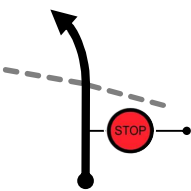

Sección	T.C. 5	C.H. 5A	KMS.	H:MM	Km/h.	Sector
3	PEGO-VALL D'ALCALÀ	 RGR./P.A. C Pego IN	46.83	1:03	44.6	9

KMS.		DIRECCIÓN DIRECTION	INFORMACIONES ADICIONALES ADDITIONAL INFORMATIONS	KMS. REGRESS.
TOTAL	PART.			
0.000		1  15.030	ND    38.834495 -00.130123	46.830
1.620	1.620	2  13.410	ND  38.835053 -00.141875	45.210
3.400	1.780	3  11.630	ND  38.832464 -00.158665	43.430
5.390	1.990	4  9.640	ND  38.827890 -00.175316	41.440
6.430	1.040	5  8.600	ND  38.825953 -00.185905	40.400

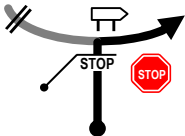
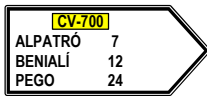
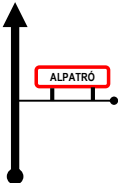
Sección	T.C. 5	C.H. 5A	KMS.	H:MM	Km/h.	Sector
3	PEGO-VALL D'ALCALÀ	 RGR./P.A. C Pego IN	46.83	1:03	44.6	9

KMS.		DIRECCIÓN DIRECTION	INFORMACIONES ADICIONALES ADDITIONAL INFORMATIONS	KMS. REGRESS.
TOTAL	PART.			
8.410	1.980	6 	ND  38.819021 -00.196297	38.420
10.420	2.010	7 	ND  38.814060 -00.212348	36.410
12.250	1.830	8 	ND X CV-712   38.804184 -00.224627	34.580
14.090	1.840	9 	CV-712  38.800376 -00.240074	32.740
15.030	0.940	10 	CV-712  38.797474 -00.249576	31.800

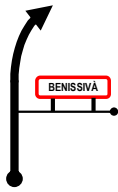



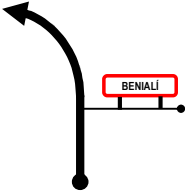
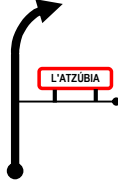
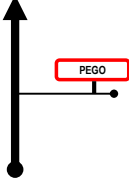
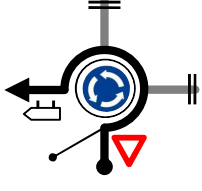
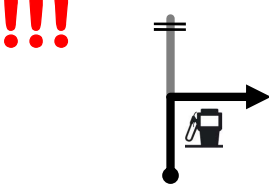

Sección	T.C. 5	C.H. 5A	KMS.	H:MM	Km/h.	Sector
3	PEGO-VALL D'ALCALÀ	 RGR./P.A. C Pego IN	46.83	1:03	44.6	9

KMS.		DIRECCIÓN DIRECTION	INFORMACIONES ADICIONALES ADDITIONAL INFORMATIONS	KMS. REGRESS.
TOTAL	PART.			
15.330	0.300	11 	CV-712  TC 5  38.795997 -00.252336	31.500
21.010	5.680	12 	CV-712 X CV-700  ALPATRÓ 7 BENIALÍ 12 PEGO 24	25.820
27.570	6.560	13 	CV-700 X URB. 	19.260
30.110	2.540	14 	CV-700 X URB. 	16.720
32.160	2.050	15 	CV-700 X URB. 	14.670

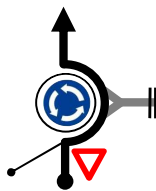
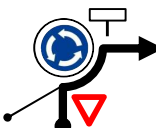
Sección	T.C. 5	C.H. 5A	KMS.	H:MM	Km/h.	Sector
3	PEGO-VALL D'ALCALÀ	 RGR./P.A. C Pego IN	46.83	1:03	44.6	9

KMS.		DIRECCIÓN DIRECTION	INFORMACIONES ADICIONALES ADDITIONAL INFORMATIONS	KMS. REGRESS.
TOTAL	PART.			
33.000	0.840		CV-700 X URB. BENIALÍ	13.830
42.030	9.030		CV-700 X URB. L'ATZÚBIA	4.800
44.900	2.870		CV-700 X URB. PEGO	1.930
45.120	0.220		URB. CV-715 OLIVA Avda. Alcalde Fdo. Alemany PEGO	1.710
45.830	0.710		URB. Avda. Joan Carles I PEGO	1.000

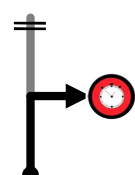
Sección	T.C. 5	C.H. 5A	KMS.	H:MM	Km/h.	Sector
3	PEGO-VALL D'ALCALÀ	 RGR./P.A. C Pego IN	46.83	1:03	44.6	9

KMS.		DIRECCIÓN DIRECTION	INFORMACIONES ADICIONALES ADDITIONAL INFORMATIONS	KMS. REGRESS.
TOTAL	PART.			
46.390	0.560	21 	URB. Avda. Joan Carles I PEGO	0.440
46.550	0.160	22 	URB.  Avda. del Mar PEGO	0.280
46.710	0.160	23 	URB.  C. Dènia PEGO	0.120
46.830	0.120	24 	URB.  Parque Asistencia C IN Passeig del Clot PEGO	0.000









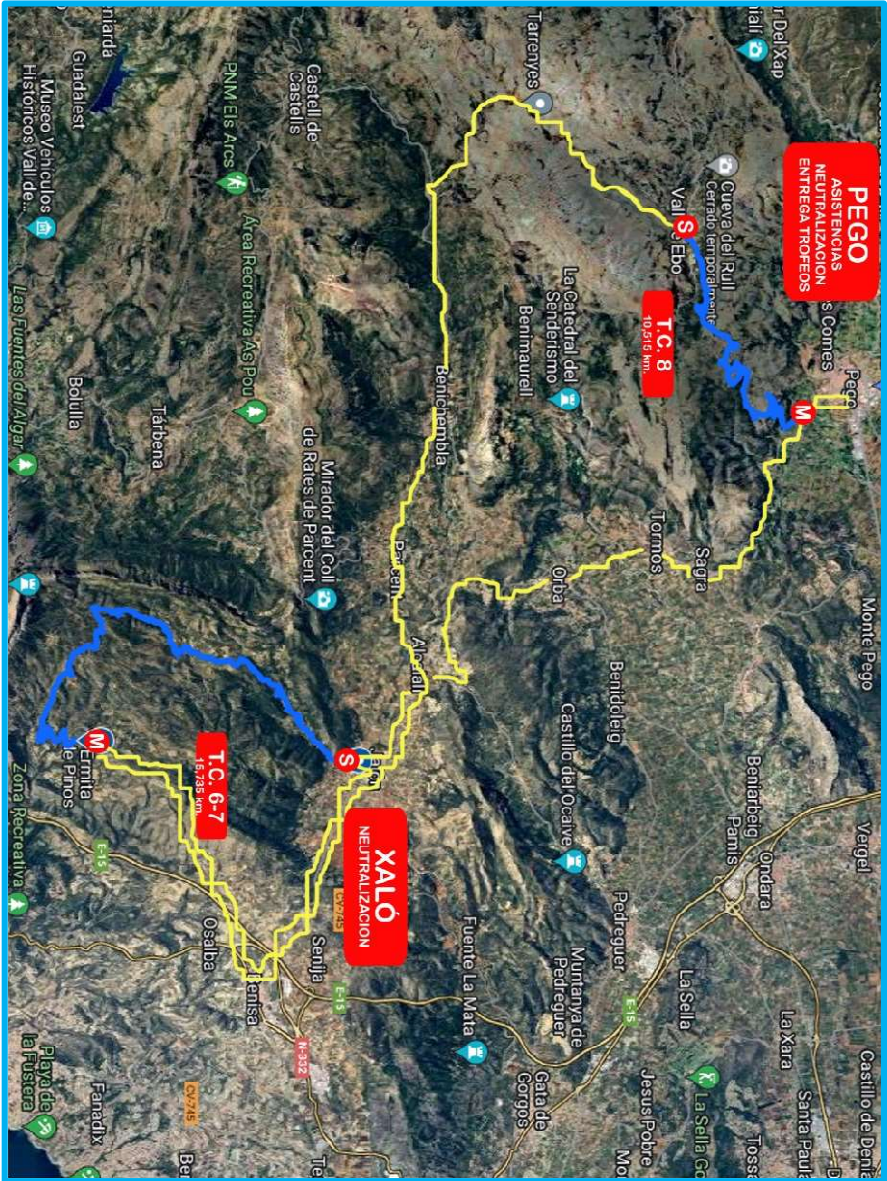

Notas:

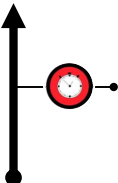

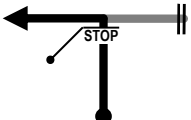

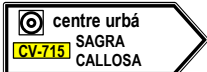
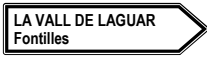
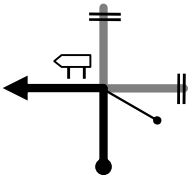
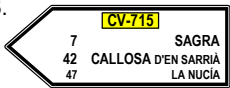
4^a SECCIÓN

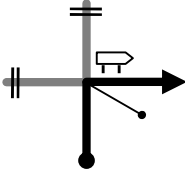

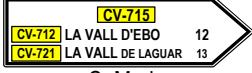



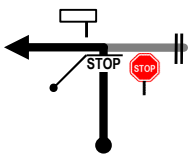
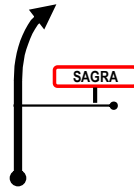
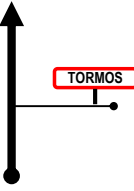
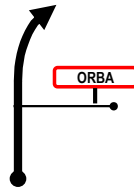

Sección	C.H. 5B	C.H. 6	KMS.	H:MM	Km/h.	Sector
4	P.Asistencia C Pego OUT 	Xaló	21.97	0:30	43.9	10

KMS.		DIRECCIÓN DIRECTION	INFORMACIONES ADICIONALES ADDITIONAL INFORMATIONS	KMS. REGRESS.
TOTAL	PART.			
0.000		1 	URB.  Parque Asistencia C OUT Passeig del Clot PEGO	21.970
0.040	0.040	2 	URB. C. Dènia PEGO	21.930
0.130	0.090	3 	URB.   C. Sant Rafael PEGO	21.840
0.510	0.380	4 	URB.   Avda. de Fontilles PEGO	21.460
0.830	0.320	5 	URB.   C. Murla PEGO	21.140



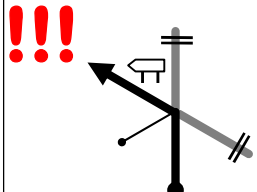
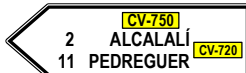
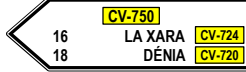
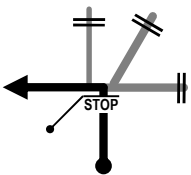

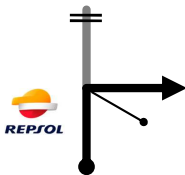
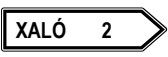
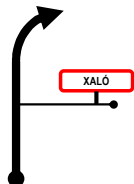



Sección	C.H. 5B	C.H. 6	KMS.	H:MM	Km/h.	Sector
4	P.Asistencia C Pego OUT	Xaló	21.97	0:30	43.9	10

KMS.		DIRECCIÓN DIRECTION	INFORMACIONES ADICIONALES ADDITIONAL INFORMATIONS	KMS. REGRESS.
TOTAL	PART.			
1.070	0.240	6 	URB. X (CV-715) ORBA SAGRA ← C. Mestre Berenguer PEGO	20.900
7.860	6.790	7 	CV-715 X URB. SAGRA	14.110
9.080	1.220	8 	CV-715 X URB. TORMOS	12.890
11.400	2.320	9 	CV-715 X URB. ORBA	10.570
12.040	0.640	10 	URB. X CV-715 PARCENT CV-715 6 BENIDORM 47	9.930

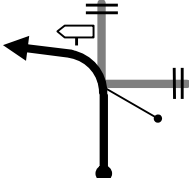

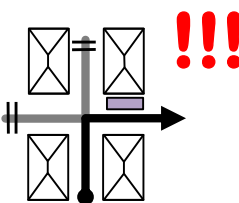

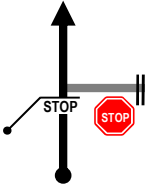
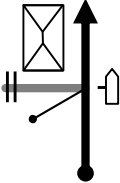
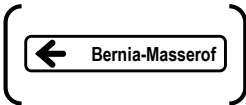
Sección	C.H. 5B	C.H. 6	KMS.	H:MM	Km/h.	Sector
4	P.Asistencia C Pego OUT	Xaló	21.97	0:30	43.9	10

KMS.		DIRECCIÓN DIRECTION	INFORMACIONES ADICIONALES ADDITIONAL INFORMATIONS	KMS. REGRESS.
TOTAL	PART.			
13.000	0.960	11 	CV-715 	8.970
15.475	2.475	12 	CV-715 X CV-750  	6.495
17.510	2.035	13 	CV-750 X URB.  ALCALALÍ	4.460
17.600	0.090	14 	URB. X CV-750 	4.370
19.620	2.020	15 	CV-750 X URB. 	2.350

Sección	C.H. 5B	C.H. 6	KMS.	H:MM	Km/h.	Sector
4	P.Asistencia C Pego OUT	Xaló	21.97	0:30	43.9	10

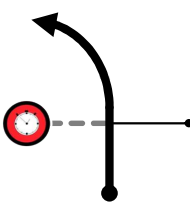
KMS.		DIRECCION DIRECTION	INFORMACIONES ADICIONALES ADDITIONAL INFORMATIONS	KMS. REGRESS.
TOTAL	PART.			
20.340	0.720	16 	URB. (CV-749)  Avda. del Rey Juan Carlos I XALÓ	1.630
20.610	0.270	17 	URB. (CV-749)  Avda. San Domenech Xaló	1.360
20.770	0.160	18 	URB.  C. de la Iglesia Xaló	1.200
20.830	0.060	19 	URB. (CV-749) C. de la Iglesia Xaló	1.140
21.740	0.910	20 	CV-749  38.731536 -00.013433	 0.230

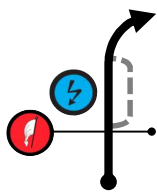
Sección	C.H. 5B	C.H. 6	KMS.	H:MM	Km/h.	Sector
4	P.Asistencia C Pego OUT	Xaló	21.97	0:30	43.9	10

KMS.		DIRECCIÓN DIRECTION	INFORMACIONES ADICIONALES ADDITIONAL INFORMATIONS	KMS. REGRESS.
TOTAL	PART.			
21.970	0.230	21 	CV-749  38.730500 -00.015375	0.000
22.080	0.110	22 	CV-749  38.729988 -00.015812	



Notas:



TC6

XALÓ TC PLUS (D1)

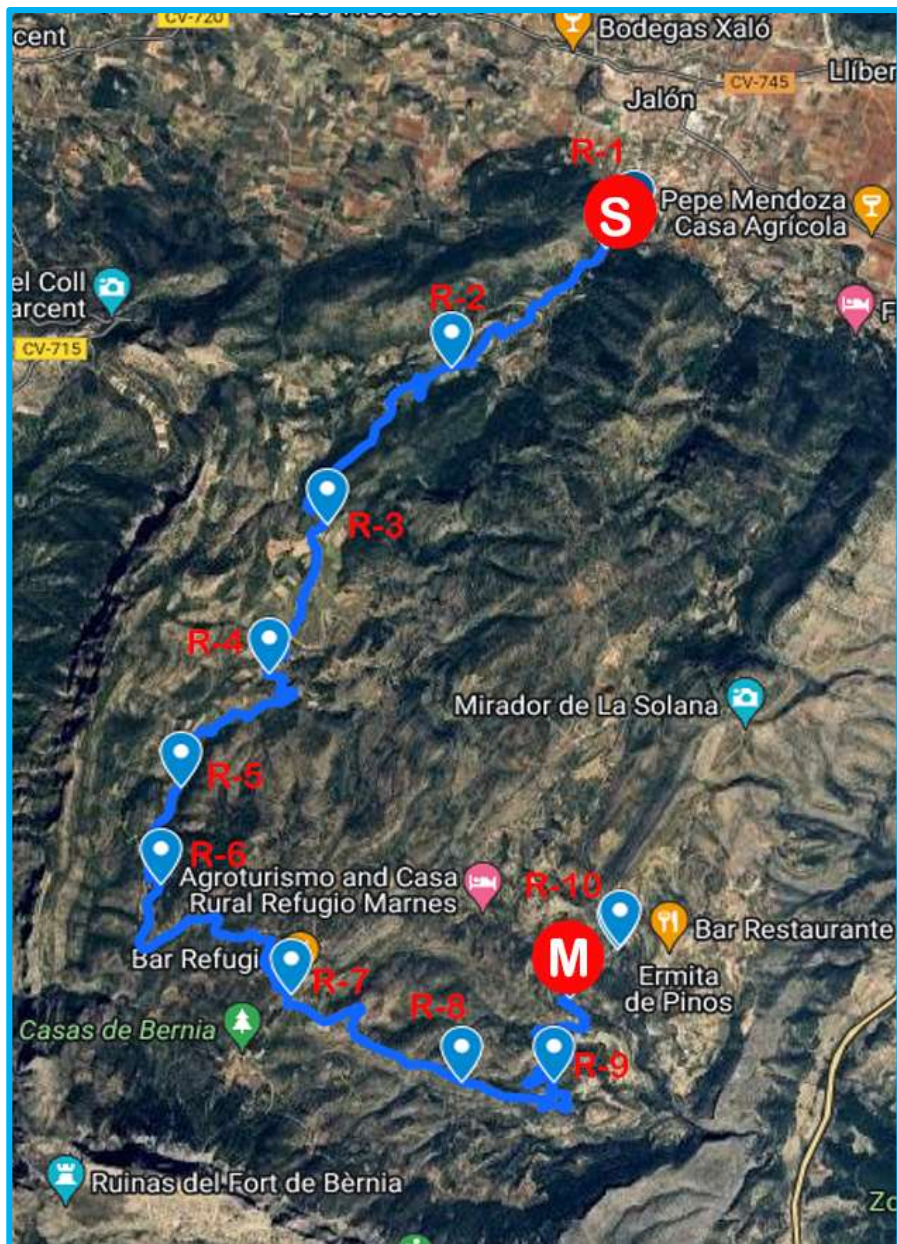

XALÒ	T.C. D1-D2	DISTANCIA T.C. 15,735 km.
SALIDA TC P.K.1,995 km. CV-749	CONTROL HOR. P.K. 1,750 km. CV-749	

38.729988, -0.015812



38.730500, -0.015375

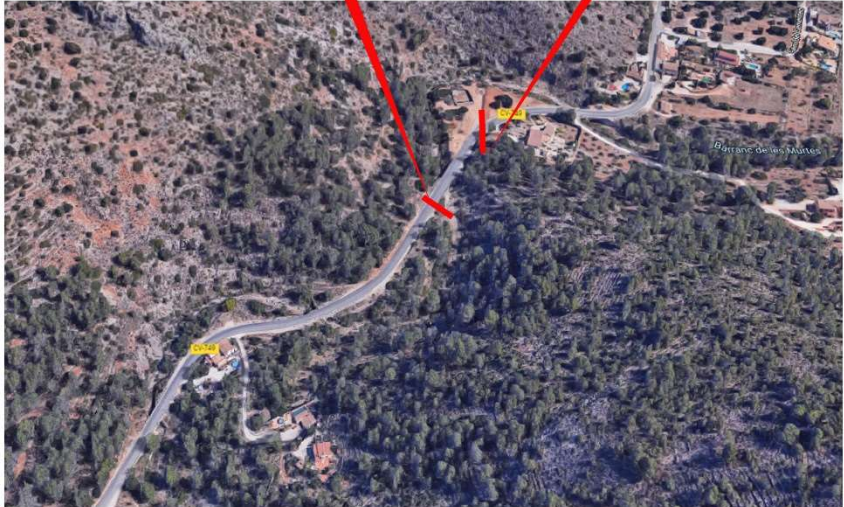



XALÒ	T.C. D1-D2	DISTANCIA T.C. 15,735 km.
META T.C. P.K. 17,730 CV-749	CONTROL STOP P.K. 18,550 CV- 749	

38.676105, -0.018816











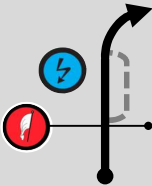

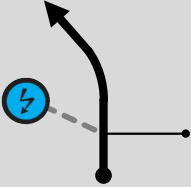

38.679547, -0.014725

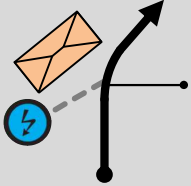

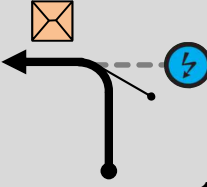

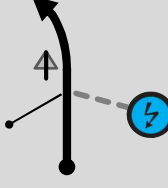





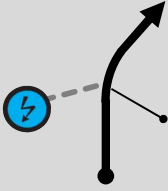

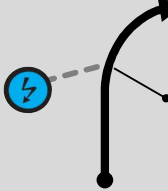

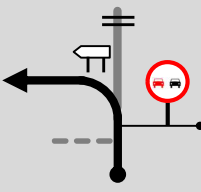

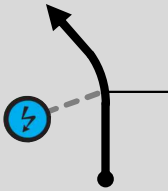

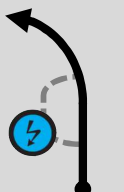



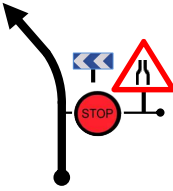

Sección	T.C. 6	C.H. 6A	KMS.	H:MM	Km/h.	Sector
4	XALÓ TC Plús	 Neutralización Xalò IN	31.40	1:00	31.4	11

KMS.		DIRECCIÓN DIRECTION	INFORMACIONES ADICIONALES ADDITIONAL INFORMATIONS	KMS. REGRESS.
TOTAL	PART.			
0.000			CV-749    38.729988 -00.015812	31.400
1.800	1.800		CV-749  38.721478 -00.028944	29.600
3.950	2.150		CV-749  38.710125 -00.039708	27.450
5.400	1.450		CV-749  38.699385 -00.044675	26.000
7.200	1.800		CV-749  38.691251 -00.052235	24.200

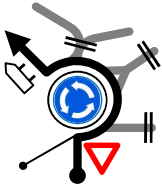

Sección	T.C. 6	C.H. 6A	KMS.	H:MM	Km/h.	Sector
4	XALÓ TC Plus	 Neutralización Xalò IN	31.25	1:00	31.3	11

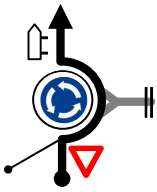
KMS.		DIRECCIÓN DIRECTION	INFORMACIONES ADICIONALES ADDITIONAL INFORMATIONS	KMS. REGRESS.
TOTAL	PART.			
8.360	1.160	6  7.375	CV-749  38.684244 -00.053857	22.890
10.790	2.430	7  4.945	CV-749  38.676437 -00.042851	20.460
10.840	0.050	8  4.895	CV-749  38.675521 -00.043066	20.410
12.650	1.810	9  3.085	CV-749  38.670082 -00.028049	18.600
13.960	1.310	10  1.775	CV-749  38.670149 -00.020145	17.290





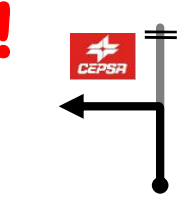
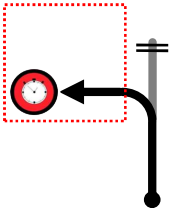

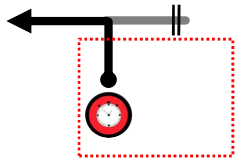

Sección	T.C. 6	C.H. 6A	KMS.	H:MM	Km/h.	Sector
4	XALÓ TC Plús	 Neutralización Xalò IN	31.25	1:00	31.3	11

KMS.		DIRECCIÓN DIRECTION	INFORMACIONES ADICIONALES ADDITIONAL INFORMATIONS	KMS. REGRESS.
TOTAL	PART.			
15.735	1.775	11  0.000	CV-749  38.676105 -00.018816	15.515
16.650	0.915	12 	CV-749   38.679547 -00.014725	14.600
16.700	0.050	13 	CV-749 38.679748 -00.014765	14.550
25.460	8.760	14 	CV-749 X CV-750 	5.790
30.850	5.390	15 	CV-749 X URB.  XALÓ	0.400

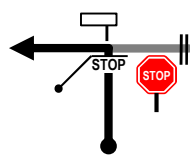
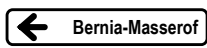
Sección	T.C. 6	C.H. 6A	KMS.	H:MM	Km/h.	Sector
4	XALÓ TC Plus	 Neutralización Xalò IN	31.40	1:00	31.4	11

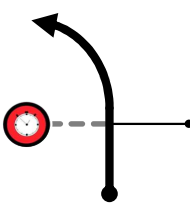
KMS.		DIRECCIÓN DIRECTION	INFORMACIONES ADICIONALES ADDITIONAL INFORMATIONS	KMS. REGRESS.
TOTAL	PART.			
31.050	0.200	 <p>16</p>	URB. Camí del Cementeri XALÓ	0.350
31.400	0.350	 <p>17</p>	URB.  Neutralización 40' IN Camí del Cementeri XALÓ	0.000

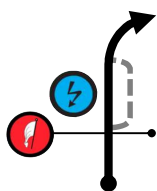
Sección	C.H. 6B	C.H. 7	KMS.	H:MM	Km/h.	Sector
4	Neutralización Pego OUT 	Xalò	1.27	0:15	5.1	12

KMS.		DIRECCIÓN DIRECTION	INFORMACIONES ADICIONALES ADDITIONAL INFORMATIONS	KMS. REGRESS.
TOTAL	PART.			
0.000		1 	URB.  Neutralización OUT Camí del Cementeri XALÓ	1.270
0.600	0.600	2 	CV-749  38.731536 -00.013433	0.670 
1.270	0.670	3 	CV-749  38.730500 -00.015375	0.000
1.360	0.090	4 	CV-749  38.729988 -00.015812	



Notas:



TC7

XALÓ (D2)

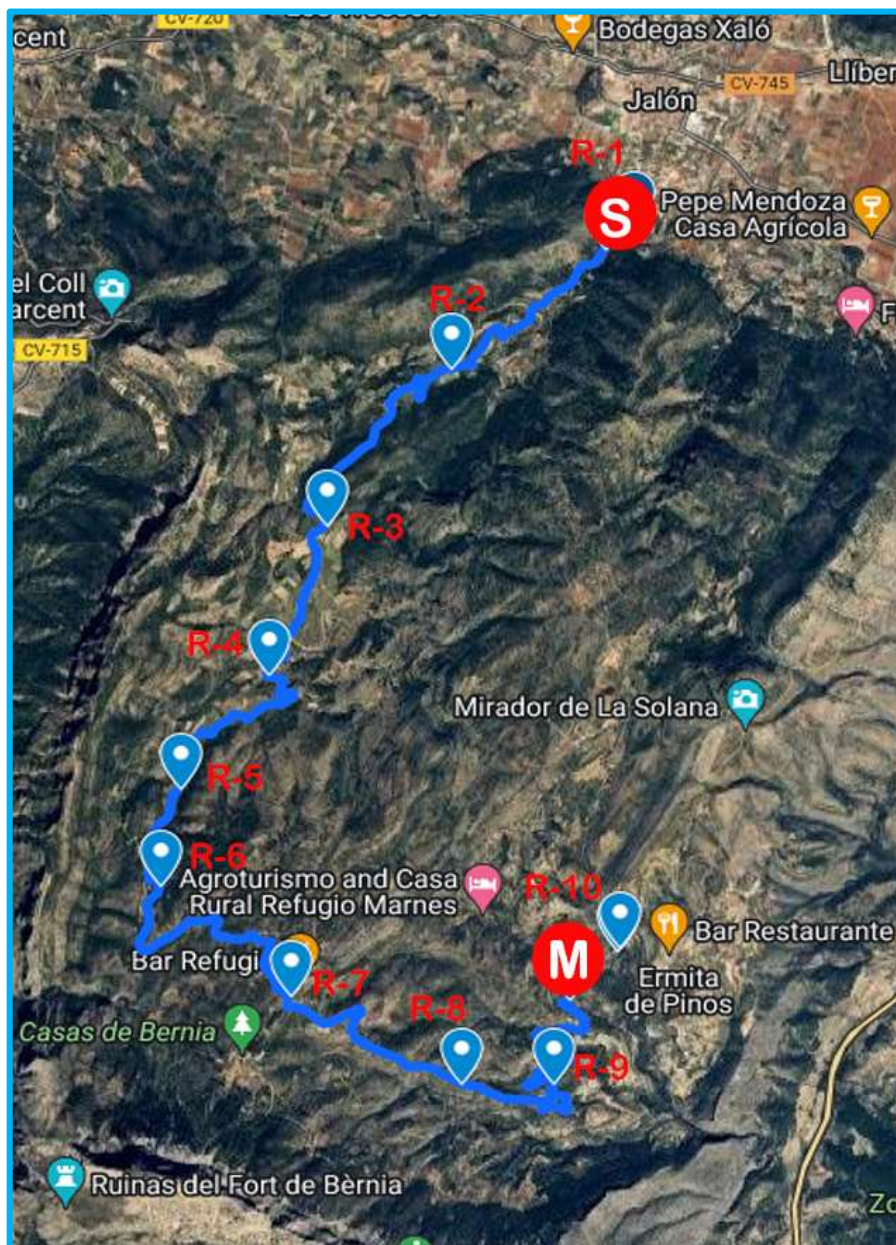

XALÒ	T.C. D1-D2	DISTANCIA T.C. 15,735 km.
SALIDA TC P.K.1,995 km. CV-749	CONTROL HOR. P.K. 1,750 km. CV-749	

38.729988, -0.015812



38.730500, -0.015375



XALÒ	T.C. D1-D2	DISTANCIA T.C. 15,735 km.
META T.C. P.K. 17,730 CV-749	CONTROL STOP P.K. 18,550 CV- 749	

38.676105, -0.018816





38.679547, -0.014725













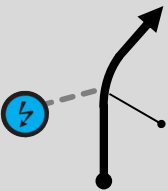
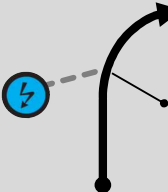
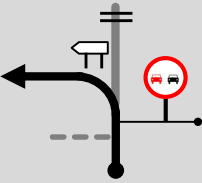

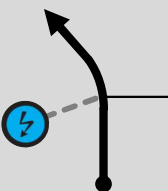
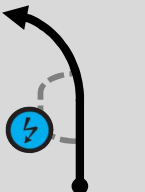



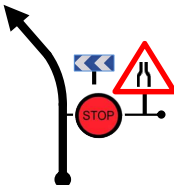

Sección	T.C. 7	C.H. 8	KMS.	H:MM	Km/h.	Sector
4	XALÒ	Vall d'Ebo	58.03	1:16	45.8	13

KMS.		DIRECCIÓN DIRECTION	INFORMACIONES ADICIONALES ADDITIONAL INFORMATIONS	KMS. REGRESS.
TOTAL	PART.			
0.000			CV-749 38.729988 -00.015812	58.030
1.800	1.800		CV-749 38.721478 -00.028944	56.230
3.950	2.150		CV-749 38.710125 -00.039708	54.080
5.400	1.450		CV-749 38.699385 -00.044675	52.630
7.200	1.800		CV-749 38.691251 -00.052235	50.830



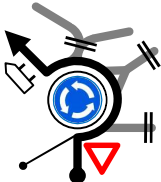

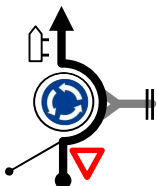

Sección	T.C. 7	C.H. 8	KMS.	H:MM	Km/h.	Sector
4	XALÒ	Vall d'Ebo	58.03	1:16	45.8	13

KMS.		DIRECCIÓN DIRECTION	INFORMACIONES ADICIONALES ADDITIONAL INFORMATIONS	KMS. REGRESS.
TOTAL	PART.			
8.360	1.160	6 	CV-749 38.684244 -00.053857	49.670
10.790	2.430	7 	CV-749 38.676437 -00.042851	47.240
10.840	0.050	8 	CV-749  38.675521 -00.043066	47.190
12.650	1.810	9 	CV-749 38.670082 -00.028049	45.380
13.960	1.310	10 	CV-749 38.670149 -00.020145	44.070

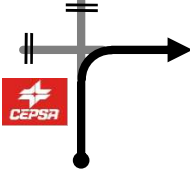

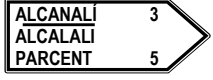

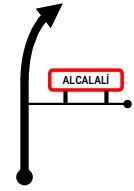

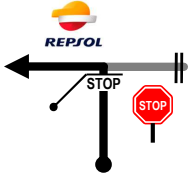

Sección	T.C. 7	C.H. 8	KMS.	H:MM	Km/h.	Sector
4	XALÒ	 Vall d'Ebo	58.03	1:16	45.8	13

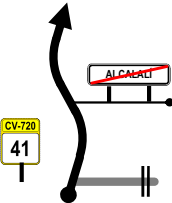
KMS.		DIRECCIÓN DIRECTION	INFORMACIONES ADICIONALES ADDITIONAL INFORMATIONS	KMS. REGRESS.
TOTAL	PART.			
15.735	1.775	11  0.000	CV-749  38.676105 -00.018816	42.295
16.650	0.915	12 	CV-749   38.679547 -00.014725	41.380
16.700	0.050	13 	CV-749 38.679748 -00.014765	41.330 
25.460	8.760	14 	CV-749 X CV-750 	32.570
30.850	5.390	15 	CV-750 X URB.  XALÒ	27.180

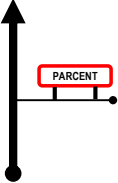

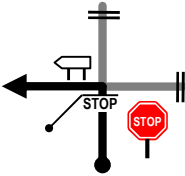
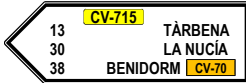
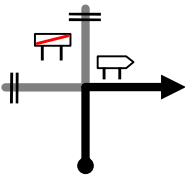

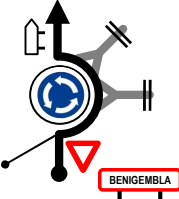

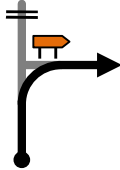

Sección	T.C. 7	C.H. 8	KMS.	H:MM	Km/h.	Sector
4	XALÒ	Vall d'Ebo	58.03	1:16	45.8	13

KMS.		DIRECCIÓN DIRECTION	INFORMACIONES ADICIONALES ADDITIONAL INFORMATIONS	KMS. REGRESS.
TOTAL	PART.			
31.090	0.240	16 	URB. Avda. Joanot Martorell XALÒ	26.940
31.520	0.430	17 	URB. (CV-750)  Avda. de les Hortes XALÒ	26.510
32.100	0.580	18 	URB. X CV-750 	25.930
34.365	2.265	19 	CV-750 X URB. 	23.665
34.872	0.507	20 	URB. ALCALALÍ	23.158



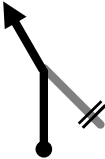
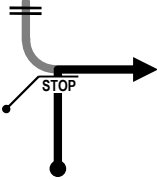
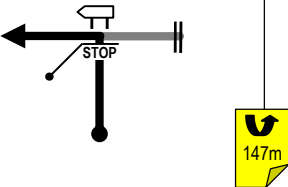

Sección	T.C. 7	C.H. 8	KMS.	H:MM	Km/h.	Sector
4	XALÒ	 Vall d'Ebo	58.03	1:16	45.8	13

KMS.		DIRECCIÓN DIRECTION	INFORMACIONES ADICIONALES ADDITIONAL INFORMATIONS	KMS. REGRESS.
TOTAL	PART.			
35.085	0.213	21 	URB. X CV-720 	22.945
36.960	1.875	22 	CV-720 X URB. 	21.070
37.645	0.685	23 	URB.  PARCENT	20.385
37.750	0.105	24 	URB. X CV-720 	20.280
41.730	3.980	25 	CV-720 X URB.  	16.300

Sección	T.C. 7	C.H. 8	KMS.	H:MM	Km/h.	Sector
4	XALÒ	 Vall d'Ebo	58.03	1:16	45.8	13

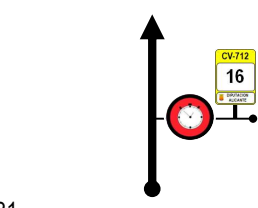
KMS.		DIRECCIÓN DIRECTION	INFORMACIONES ADICIONALES ADDITIONAL INFORMATIONS	KMS. REGRESS.
TOTAL	PART.			
47.875	6.145	 	CV-720 X Camí Vall d'Ebo 	10.155
57.022	9.147		C.V.d E. X URB. 	1.008
57.262	0.240		URB. C. del Calvaro VALL D'EBO	0.768
57.439	0.177		URB. X CV-712	0.591
57.883	0.444		CV-712   38.807428 -00.157006	 0.147

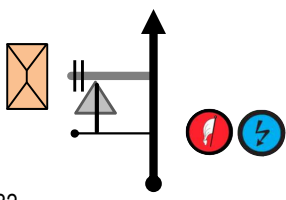
Sección	T.C. 7	C.H. 8	KMS.	H:MM	Km/h.	Sector
4	XALÒ	 Vall d'Ebo	58.03	1:16	45.8	13

KMS.		DIRECCIÓN DIRECTION	INFORMACIONES ADICIONALES ADDITIONAL INFORMATIONS	KMS. REGRESS.
TOTAL	PART.			
58.030	0.147	31 	CV-712   38.809143 -00.154852	0.000
58.154	0.124	32 	CV-712   38.808734 -00.155687	



Notas:



TC8

VALL D'EBO (E1)

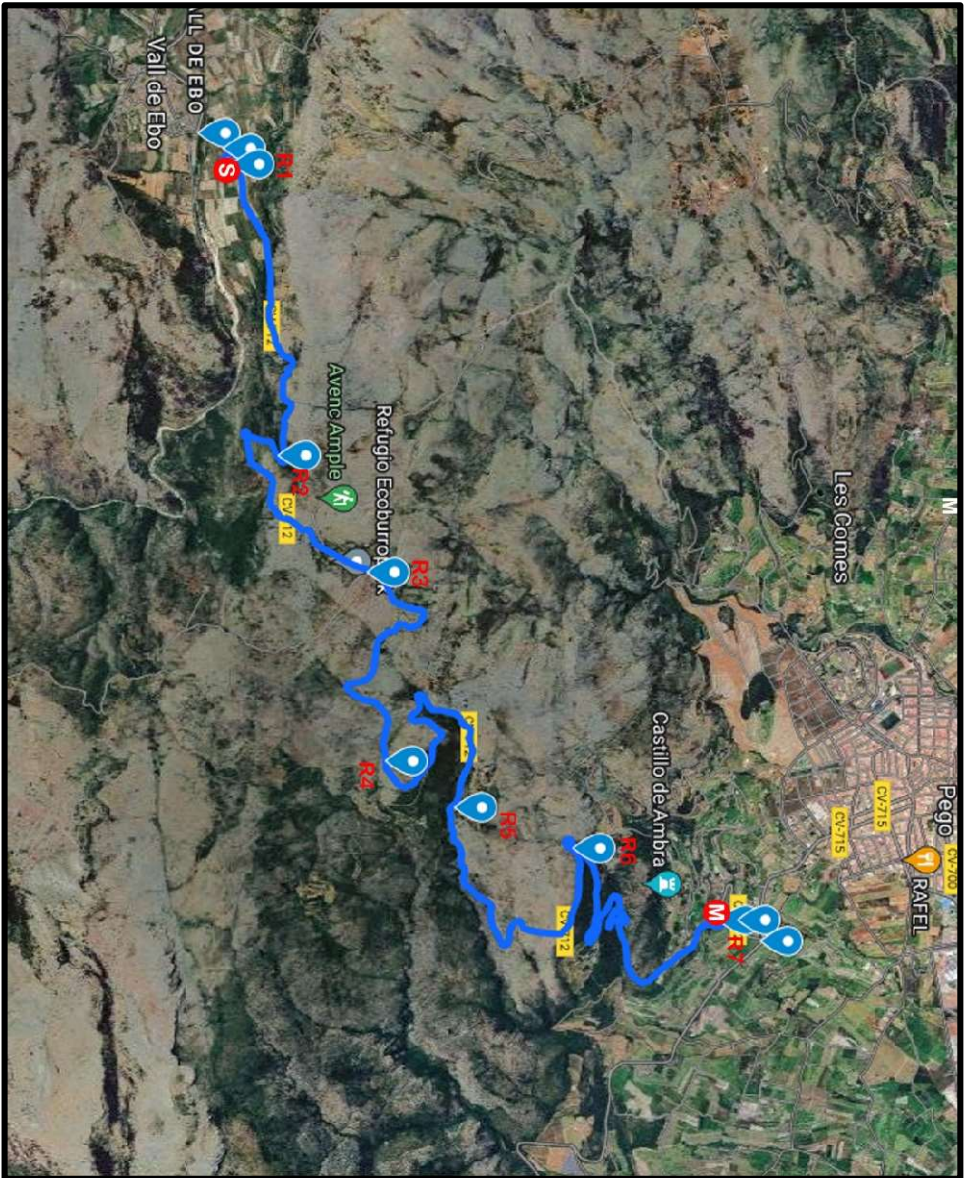

VALL D'EBO	T.C. E1	DISTANCIA T.C. 10,515 km.
SALIDA T.C. CV-712 P.K. 16,154	C.H. CV-712 P.K. 16,000	

38.808734, -0.155687

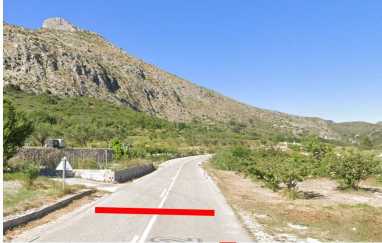

38.809143, -0.154852

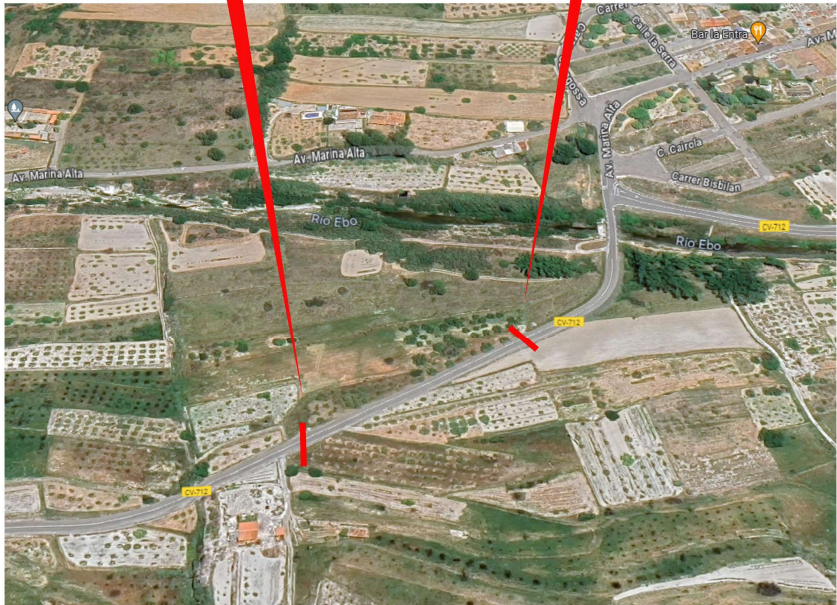



VALL D'EBO	T.C. E1	DISTANCIA T.C. 10,797 km.
META TC CV-712 P.K. 26,520	CONTROL STOP CV-712 P.K. 27,000	





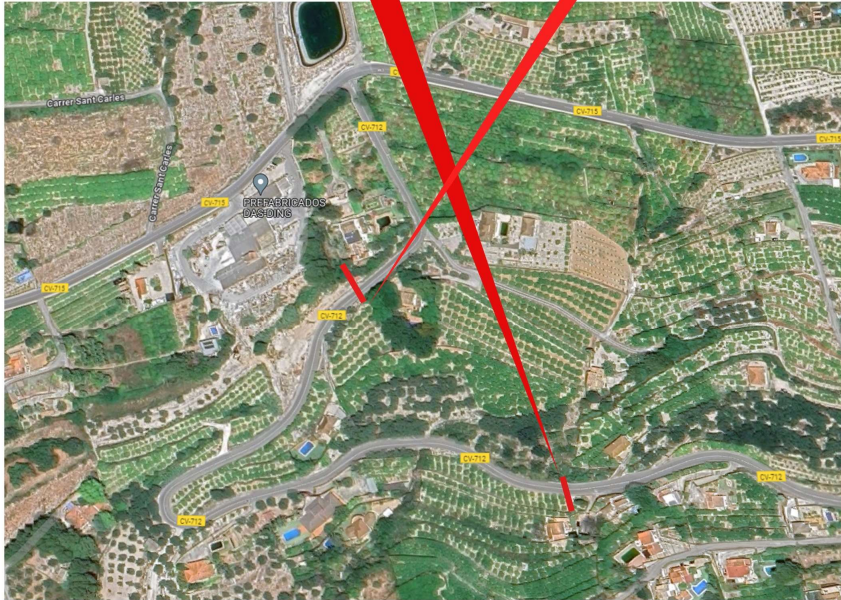



















38.82959, -0.10618











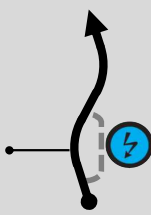

38.83234, -0.11051

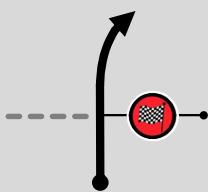

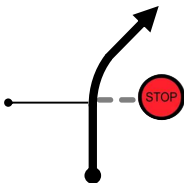

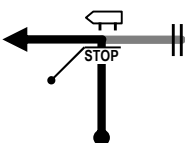

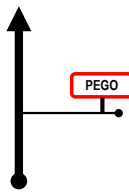
Sección	T.C. 8	C.H. 8A	KMS.	H:MM	Km/h.	Sector
4	VALL D'EBO 	Parque Cerrado Pego	14.13	0:21	40.4	14

KMS.		DIRECCIÓN DIRECTION	INFORMACIONES ADICIONALES ADDITIONAL INFORMATIONS	KMS. REGRESS.
TOTAL	PART.			
0.000		1      10.515	CV-712    38.808734 -00.155687	14.130
1.811	1.811	2    8.704	CV-712   38.811188 -00.137378	12.319
3.191	1.380	3    7.324	CV-712  38.815435 -00.130327	10.939
4.741	1.550	4   5.774	CV-712  38.816261 -00.118760	9.389
6.481	1.740	5    4.034	CV-712  38.819589 -00.115994	7.649

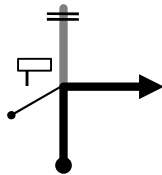
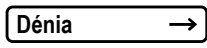
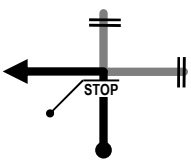
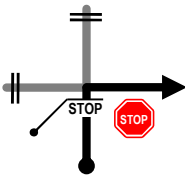
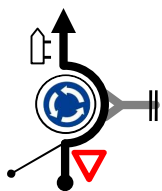

Sección	T.C. 8	C.H. 8A	KMS.	H:MM	Km/h.	Sector
4	VALL D'EBO 	Parque Cerrado Pego	14.13	0:21	40.4	14

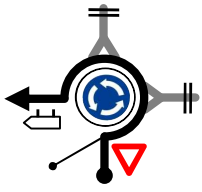
KMS.		DIRECCIÓN DIRECTION	INFORMACIONES ADICIONALES ADDITIONAL INFORMATIONS	KMS. REGRESS.
TOTAL	PART.			
8.401	1.920	6 	CV-712  38.825177 -00.113587	5.729
10.515	2.114	7 	CV-712  38.829590 -00.106180	3.615
10.991	0.476	8 	CV-712   38.832340 -00.110510	3.139
11.221	0.230	9 	CV-712 X CV-715  38.834126 -00.107807	2.909
11.633	0.412	10 	CV-715 X URB.  C. Mestre Berenguer PEGO	2.497

Sección	T.C. 8	C.H. 8A	KMS.	H:MM	Km/h.	Sector
4	VALL D'EBO 	Parque Cerrado Pego	14.13	0:21	40.4	14

KMS.		DIRECCIÓN DIRECTION	INFORMACIONES ADICIONALES ADDITIONAL INFORMATIONS	KMS. REGRESS.
TOTAL	PART.			
12.001	0.368	11 	URB.  C. Murla PEGO	2.129
12.241	0.240	12 	URB. Avda. Fontilles PEGO	1.889
12.561	0.320	13 	URB. C. Sant Rafael PEGO	1.569
12.931	0.370	14 	URB. (CV-678)  C. Sant Rafael PEGO	1.199
13.121	0.190	15 	URB.  Avda. Joan Carles I PEGO	1.009

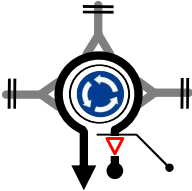
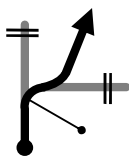
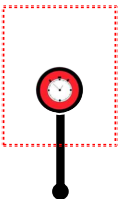
Sección	T.C. 8	C.H. 8A	KMS.	H:MM	Km/h.	Sector
4	VALL D'EBO 	Parque Cerrado Pego	14.13	0:21	40.4	14

KMS.		DIRECCIÓN DIRECTION	INFORMACIONES ADICIONALES ADDITIONAL INFORMATIONS	KMS. REGRESS.
TOTAL	PART.			
13.711	0.590	16 	URB. Avda. Joan Carles I PEGO	0.419
14.041	0.330	17 	URB. Passeig el Clot PEGO	0.089
14.130	0.089	18 	URB.  Parque Cerrado Fin de Rallye Passeig el Clot PEGO	0.000

OK

**IF MEDICAL AID IS NOT NEEDED, PLEASE SHOW TO OTHER COMPETITORS
MOSTRAR HACIA EL RECORRIDO EN CASO DE NO NECESITAR ASISTENCIA MÉDICA**

SOOS

**IF YOU MEDICAL AID, PLEAEESE SHOW TO OTHER COMPETITORS
MOSTRAR HACIA EL RECORRIDO EN CASO DE NECESITAR ASISTENCIA MÉDICA**